

SECTION 7
Load Securement

BALL			
Hitches	7-4-5		
BARS, LOAD SECUREMENT			
Jack	7-7		
Series F & SAF-T-Lok	7-7		
Winch	7-5		
BINDER CHAIN ASSEMBLIES	7-2		
BINDER, LEVER			
E-Z Pro Cam Release Lever	7-2		
Midget Load Binder	7-2		
Snubbing Load Binder	7-2		
Standard Lever Type Load Binder	7-1-2		
BINDER, RATCHET			
Quic-Link	7-1		
Standard	7-1		
Turnbuckle	7-2-3		
BINDERS			
Load	7-1-3		
BUCKLE			
Cam	7-8		
Ratchet	7-8		
CAM BUCKLE	7-8		
CARGO			
Net Hardware	7-8-10		
Nets	7-8-10		
CHAIN			
Binder, Assemblies	7-2		
CORNER PROTECTORS	7-5		
D RINGS, FLATBED	7-5, 7-10		
FLATBED ACCESSORIES			
Assemblies	7-5		
Corner Protectors	7-5		
D-Rings	7-5		
Floor Chain Tie-Down	7-6		
Hardware	7-8-10		
Recessed Lashing Ring	7-5		
Snapper Pins	7-5		
Tarp Ties	7-6		
Truckbed Tie-down	7-5		
Web Protectors	7-5		
Winch Bars	7-5		
FLATBED STRAPS ASSEMBLIES			
Logistic (A, E & F Track)	7-7		
Strap-All™ 1"	7-6		
2" Ratchet	7-6-7		
3" Ratchet	7-6		
4" Ratchet	7-6		
FLOOR CHAIN TIE-DOWN	7-6		
HITCHES			
Ball	7-5		
Dual Purpose	7-4		
HOOKS			
Pintle	7-4		
Tie-down Assemblies	7-8-10		
Tow	7-5		
LASHING RING	7-5		
LEVER BINDER			
E-Z Pro Cam Release Lever	7-2		
Midget Load	7-2		
Snubbing Load	7-2		
Standard Lever Type Load	7-1-2		
LOAD BINDERS			
Application, Maintenance and Warning	7-1		
Binder Chain Assemblies	7-2		
Custom Ratchet Turnbuckles	7-3		
Dimensions of Ratchet Turnbuckle	7-2-3		
E-Z Pro Cam Release Lever	7-2		
Instructions for Lever and Ratchet Binders	7-1		
Lever	7-1-2		
Midget	7-2		
Quic-Link Ratchet	7-1		
Ratchet Turnbuckles	7-2-3		
Snubbing Load Binder	7-2		
Standard Ratchet Binder	7-1		
LOAD SECUREMENT	7-1-10		
NETS, CARGO			
Hardware	7-8-10		
PINS			
Snapper	7-5		
PINTLE HOOKS			
Rigid Mounted	7-4		
Spring Mounted	7-4		
Swivel Mounted	7-4		
PROTECTORS			
Corner	7-5		
Web	7-5		
RATCHET			
Binder	7-1		
Tie-down Straps	7-6-7		
RING LASHING	7-5		
STRAPS, RUBBER	7-6		
STRAPS ASSEMBLIES, LOAD SECUREMENT			
1" Cam Buckle	7-6		
1" Ratchet	7-6		
2" Ratchet	7-6-7		
3" Ratchet	7-6		
4" Ratchet	7-6		
STRAP HARDWARE, LOAD SECUREMENT			
Cam Buckle (1")	7-8		
Chain Attachment (18")	7-9		
Cluster Hook RTJ Attachment	7-10		
Delta Ring (2" & 4")	7-10		
D-Ring 1"	7-10		
Flat Hook (1"-4")	7-8-9		
Grab Hook Assembly (3/8")	7-9		
Logistic Track Fitting (A, E & F Track)	7-7, 7-10		
Ratchet Buckles (1"-4")	7-8		
Snap Hooks (1"-2")	7-9		
Vinyl Coated Wire Hooks (1")	7-9		
Wire Hooks (1"-3")	7-9		
TARP TIES, FLATBED	7-6		
TIE-DOWN ASSEMBLIES, TRUCK BED	7-5		
TIE-DOWN CHAIN ASSEMBLIES	7-2		
TIE-DOWN HARDWARE			
Cam Buckle (1")	7-8		
Chain Attachment (18")	7-9		
Cluster Hook RTJ Attachment	7-10		
Delta Ring (2" & 4")	7-10		
D-Ring 1"	7-10		
Flat Hook (1"-4")	7-8-9		
Grab Hook Assembly (3/8")	7-9		
Logistic Track Fitting (A, E & F Track)	7-10		
Pan Fitting with Ring and Stud	7-10		
Ratchet Buckles (1"-4")	7-8		
Snap Hooks (1"-2")	7-9		
Vinyl Coated Wire Hooks (1")	7-9		
Wire Hooks (1"-3")	7-9		
TIE-DOWN STRAPS ASSEMBLIES			
1" Cam Buckle Straps	7-6		
1" Ratchet Straps	7-6		
2" Ratchet Straps	7-6		
3" Ratchet Straps	7-6		
4" Ratchet Straps	7-6		
Logistic Straps (A, E & F Track)	7-7, 7-10		
TOW HOOKS	7-5		
TRAILER HITCHES			
Ball	7-5		
Dual Purpose	7-4		
TURNBUCKLE, RATCHET			
Custom Ratchet Turnbuckles	7-3		
Dimensions of Ratchet Turnbuckles Components	7-2-3		
Eye & Eye Turnbuckle (Type D)	7-2		
Eye & Jaw Turnbuckle (Type DJ)	7-2		
Jaw & Jaw Turnbuckle (Type J)	7-2		
WEB PROTECTORS	7-5		
WINCH BARS, FLATBED	7-5		
WINCH FLATBED			
Portable	7-3		
Sliding	7-3		
Storable Disc	7-3		
Weld-On	7-3		
WINCH, WEBBING			
Portable	7-3		
Sliding	7-3		
Storable Disc	7-3		
Weld-On	7-3		

Load Binders

LOAD BINDERS

Warnings and Application Instructions

! WARNING!

- Failure to use this load binder properly may result in serious injury or even death to you or others.
- Do not operate load binder while standing on the load.
- Move handle with caution. It may whip - Keep body clear.
- Keep yourself out of the path of the moving handle and any loose chain laying on the handle.
- You must be familiar with state and federal regulations regarding size and number of chain systems required for securing loads on trucks.
- Always consider the safety of nearby workers as well as yourself when using load binder.
- While under tension, load binder must not bear against an object, as this will cause side load.
- Do not throw these instructions away. Keep them close at hand and share them with any others who use this load binder.
- Do not attempt to close or open the binder with more than one person.

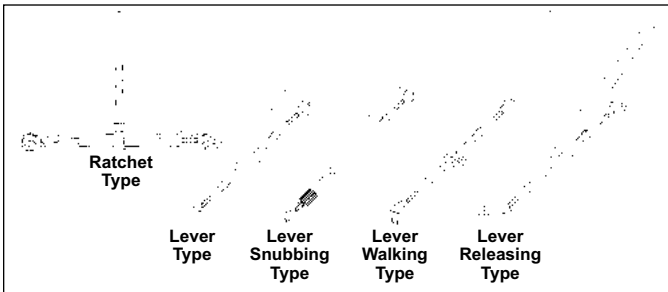

Mechanical Advantage:

Lever Type Binder = 25:1 Ratchet Type Binder = 50:1

Example: 100 pounds of effort applied to the binder results in the following force on the binder.

Lever Type: 2500 (100 lbs. x 25) lbs. of force
Ratchet Type: 5000 (100 lbs. x 50) lbs. of force

Instructions - Lever Type Load Binders

- Hook load binder to chain so you can operate it while standing on the ground. Position load binder so its handle can be pulled downward to tighten chain (see photo). **Be aware of ice, snow, rain, oil, etc. that can affect your footing. Make certain your footing is secure.**
- We specifically recommend AGAINST the use of a handle extender (cheater pipe). If sufficient leverage cannot be obtained using the lever type load binder by itself, a ratchet type binder should be used.
- If the above recommendation is disregarded and a cheater pipe is used, it must closely fit the handle and must slide down the handle until the handle projections are contacted. The pipe should be secured to the handle, for example, by a pin, so that the pipe cannot fly off the handle if you loose control and let go. The increased leverage, by using a cheater pipe, can cause deformation and failure of the chain and load binder.
- During and after tightening chain, check load binder handle position. Be sure it is in the locked position and that its bottom side touches the chain link.
- Chain tension may decrease due to load shifting during transport. To be sure the load binder remains in proper position: Secure handle to chain by wrapping the loose end of chain around the handle and the tight chain, or tie handle to chain with soft wire.
- When releasing load binder, remember there is a great deal of energy in the stretched chain. This will cause the load binder handle to move very quickly with great force when it is unlatched. **Move handle with caution. It may whip - Keep body clear.**
- **Never use a cheater pipe or handle extender to release handle.** Use a steel bar and pry under the handle and **stay out of the path of handle** as it moves upward.
- If you release the handle by hand, use an open hand under the handle and push upward. **Do not close your hand around the handle. Always keep yourself out of the path of the moving handle.**



Instructions - Ratchet Load Binders

- Position ratchet binder so it can be operated from the ground.
- **Make sure your footing is secure.**

Maintenance of All Load Binders.

- Routinely check load binders for wear, bending, cracks, nicks, or gouges. **If bending or cracks are present - Do not use load binder.**
- Routinely lubricate pivot and swivel points of Lever Binders, and pawl part and screw threads of Ratchet Binders to extend product life and reduce friction wear.

Standard Lever Type Load Binders - Lebus®

L-150

- Forged Steel-Quenched & Tempered.
- Binder toggles away from the load.



Model	Stock No.	Std. Pkg.	Min-Max Chain Size (in)	WLL (lbs)	Proof Load (lbs)	Min. Ultimate Strength (lbs)	Wt. Each (lbs)	Handle Length (in)	Take Up (in)
7-1	1048128	4	5/16-3/8	5400	10800	19000	7.02	16.00	4.50
A-1	1048146	4	3/8-1/2	9200	18400	33000	12.47	18.69	4.50
C-1	1048164	4	1/2-5/8	13000	26000	46000	19.68	21.00	4.75

Standard Ratchet Type Load - Lebus®

L-140

- For use with Grade 7 Transport Chain - Applies to R-7 only.
- New design "one piece" forged handle.
- Continuous take-up feature, infinite adjustment, gets the last half of chain.
- Utilizes standard Crosby A-323 Alloy Eye Grab Hooks.
- One Piece assembly, no bolts or nuts to loosen.
- Ratchet spring rust proofed.
- Easy operating positive ratchet.
- All load bearings or holding parts forged.

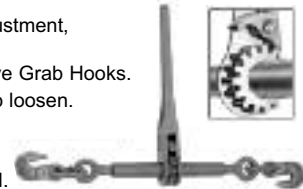

Model	Stock No.	Min-Max Chain Size (in)	WLL (lbs)	Proof Load (lbs)	Min. Ultimate Strength (lbs)	Wt. Each (lbs)	Handle Length (in)	Barrel Length (in)	Take Up (in)
R-7	1048404	5/16-3/8	6600	13200	26000	11.23	14	10	8.0
R-A	1048422	3/8-1/2	9200	18400	33000	12.83	14	10	8.0
R-C	1048440	1/2-5/8	13000	26000	46000	14.55	14	10	8.0

Note: Binders shown with Proof Load Pounds have been individually Proof Tested to these values shown, prior to shipment.

Quic-Link Ratchet Load Binder - Lebus®

R-7 "Quic-Link"

- For use with Grade 7 Transport Chain.
- Utilizes standard Crosby A-323 Alloy Eye Grab Hooks.
- New design "one piece" forged handle.
- Continuous take-up feature, infinite adjustment, gets the last half of chain.
- One Piece assembly, no bolts or nuts to loosen.
- All load bearings or holding parts forged.
- Ratchet spring rust proofed.
- Easy operating positive ratchet.



Model	Stock No.	Min-Max Chain Size (in)	WLL (lbs)	Proof Load (lbs)	Min. Ultimate Strength (lbs)	Wt. Each (lbs)	Handle Length (in)	Barrel Length (in)	Take Up (in)
R-7QL	104813	5/16-3/8	6600	13200	26000	12.25	14	10	8.0

Note: Individually Proof Tested to 13,200 Lbs. prior to shipment.

Load Securement

Load Binders/Ratchet Turnbuckles

Snubbing Load Binder - Lebus®

L-150

- Forged Steel—Quenched & Tempered.
- Spring cushion for load protection, cushions shock and away.
- Binder toggles away from the load.

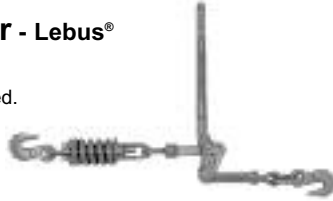

Model	Stock No.	Min-Max Chain Size (in)	WLL (lbs)	Min. Ultimate Strength (lbs)	Wt. Each (lbs)	Handle Length (lbs)	Take Up (in)	Compression Strength of Spring (lbs)
7-12	1048280	5/16-3/8	5400	16200	11.25	16.00	4.25	2300
A-12	1048306	3/8-1/2	9200	30300	18.69	18.50	4.50	3300

Midget Load Binder - Lebus®

L-130

- Forged handle, hooks and swivel link.
- Steel swivels and clevis.



Model	Stock No.	Min-Max Chain Size (in)	WLL (lbs)	Min. Ultimate Strength (lbs)	Wt. Each (lbs)	Handle Length (lbs)	Take Up (in)
W-1	1048100	3/16-1/4	1450	5100	2.57	11.25	2.40

E-Z Pro Cam Release Lever Load Binder - CM

- Provides recoilless CAM release design.
- Entirely hand releasable.
- Individually proof tested.
- Use with Grade 43 and Grade 70 Chain.



Chain Grade & Chain Size (in)		WLL (lbs)	Product Code	Approx. Take-up (in)	Wt. Each (lbs)	Std. Pack
G-43	G-70					
3/8	5/16	5,400	D48405	4-1/2	11	4

3/8" Lever Type Load Binder - CM

- Provides more control in binding and releasing without extra tools.
- Handle closes down away from load with more leverage.
- Hooks are heat treated steel.
- Functionally superior to any other on the road.
- Handles are drop forged from special bar quality steel.
- Single welded links as in binder chain for better reliability.
- More take-up for binding greater loads. Smaller handle slot with riveted nose to prevent spreading at the critical loading point.
- Meets D.O.T and C.V.S.A. requirements.



Chain Size (in)	Chain Grade	WLL* (lbs)	Product Code	Handle Length (in)	Take-up (in)	Wt. (lbs)
3/8	30,43,70,80	7,100	D48769	16	4-7/8	8-1/4

Binder Chain Assemblies

Working Load Limits: Grade 43 = 5,400 lbs./Grade 70 = 6,600 lbs.
 3/8" x 14' Grade 43 or 70 Chain with Welded or Clevis Grab Hooks
 3/8" x 16' Grade 43 or 70 Chain with Welded or Clevis Grab Hooks
 3/8" x 20' Grade 43 or 70 Chain with Welded or Clevis Grab Hooks
 3/8" x 25' Grade 43 or 70 Chain with Welded or Clevis Grab Hooks

RATCHET TURNBUCKLES

Standard Ratchet Turnbuckle

- Spring-activated pawl in handles.
- Gravity-pawl handles available as an option.
- Barrel hex-drives available for all models.
- Hand-wheel and vise-type handles available on most models.
- Barrels made from cold-drawn steel tubing not from welded pipe.
- All turnbuckles can be equipped with screw stops to decrease chances of unintentional disassembly.
- All turnbuckles can be equipped with lock nuts to decrease chances of accidental loosening.
- Turnbuckles are available galvanized for reduced maintenance in saltwater applications.
- Custom-built or specialty turnbuckles available.

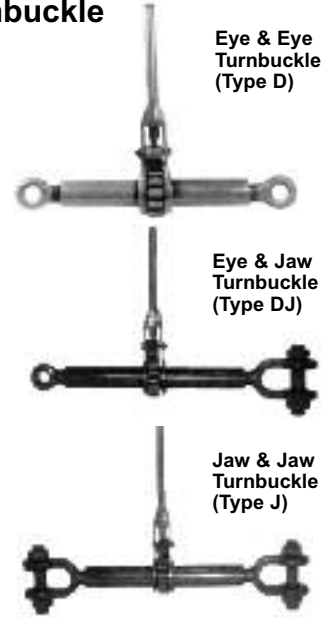

Threaded Jaws

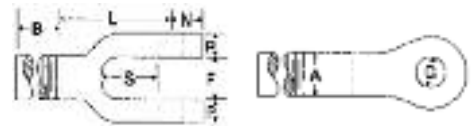

Threaded Jaw Dimensions (in)								Safe WL* Tension (lbs)
A	B	F	S	G	N	P	L	
Shank Dia.	Shank Length	Throat Opening	Throat Depth	Hole Dia.	Jaw End to Hole C/L	Cheek Thkns.	1st Thread to Hole C/L	
0.75	10.00	0.94	1.50	0.69	1.00	0.50	2.75	4,600
1.00	14.00	1.19	2.06	0.94	1.25	0.75	3.75	9,000
1.13	18.00	1.25	2.06	1.03	1.13	0.50	3.75	10,000
1.25	14.00	1.75	2.44	1.19	1.50	0.88	5.00	14,600
1.38	16.00	1.13	3.00	1.13	1.25	0.75	6.00	17,000
1.50	15.00	2.31	2.81	1.44	1.81	1.09	5.50	21,400
1.75	15.00	2.38	2.88	1.72	2.00	1.14	6.33	27,000
2.00	16.00	2.50	3.68	2.09	2.60	1.55	7.00	37,000
2.50	18.00	2.88	4.44	2.38	3.50	1.50	8.40	60,000
2.75	18.00	3.50	4.19	2.88	4.00	1.75	9.40	77,000
3.00	8.00	3.50	5.50	3.06	3.38	1.75	10.00	100,000
4.00	8.00	5.50	5.50	4.06	4.38	2.00	11.50	200,000

* Safe Working Load, in tension, provides a safety factor of approximately five to one.

Threaded Eyebolts



Threaded Eyebolt Dimensions (in)							Safe WL* (lbs)
Shank Dia.	Shank Length	Outside Eye Dia.	Max. Drilled Hole Dia.	1st Thread to Hole Center	Eye Thickness		
0.75	12.00	1.88	1.00	2.00	0.75	4,600	
0.88	12.00	2.13	1.13	2.25	0.88	6,400	
1.00	12.00	2.38	1.25	2.25	1.00	9,000	
1.13	12.00	2.75	1.38	2.00	1.13	10,000	
1.25	18.00	3.00	1.50	2.50	1.25	14,600	
1.38	24.00	3.50	1.56	2.75	1.25	19,600	
1.50	24.00	3.63	1.75	2.88	1.50	21,400	
1.75	24.00	3.25	1.69	2.75	1.50	27,000	
2.00	18.00	3.50	1.31	3.00	1.88	30,000	
2.00	18.00	4.00	1.56	3.50	1.50	30,000	
2.00	24.00	5.00	2.00	4.25	2.50	37,000	
2.50	24.00	6.00	3.00	4.50	2.75	60,000	
2.75	24.00	6.50	3.13	5.00	2.75	77,000	
3.00	6.00	6.50	3.25	5.00	3.00	100,000	
4.00	7.00	10.75	3.50	6.88	4.00	200,000	

* Safe Working Load, in tension, provides a safety factor of approximately five to one.

Ratchet Turnbuckles/Winch Products

Ratchet Turnbuckles

Specifications & Dimensions (cont.)

Double-acting handles have a spring-loaded pawl which helps to provide constant engagement of the pawl in the ratchet wheel, regardless of the position of the ratchet turnbuckle. This makes the double acting handle easier to use whether in general industry, farming, mining, construction, shipbuilding or commercial marine.

Standard hand-wheels, vise-type handles and hex-drives are available upon request.

Our industrial-use barrel is made from cold-drawn tubing and not welded pipe, making it stronger than a comparable pipe barrel. Barrels can be galvanized and fitted with grease fittings to reduce maintenance even in harsh salt-water applications.

Ratchet Handle				
MODEL NUMBER	Corresponding Barrel Dia. (in)	X (in)	H (in)	z (in)
SR 1.0	1.75	3.25	13.25	1.88
SR 1.375	2.38	4.38	22.00	3.00
SR 1.75	2.88	5.00	22.25	3.00
SR 2.0	3.50	5.63	27.50	2.75
SR 2.5	3.75	5.75	27.56	2.75
SR 3.0	4.50	6.75	29.25	2.75
SR 4.0	6.00	9.13	33.00	2.75



Ratchet Barrel				
Safe Working Load* (Tension) (lbs)	Ratchet Screw Dia. (in)	Barrel Dia. (in)	Std. Barrel Lengths (in)	Range of Adj. (in)
4,600	0.75	1.75	6 to 24	4 to 22
9,000	1.00	1.75	6 to 24	4 to 22
10,000	1.13	1.75	6 to 24	4 to 22
14,600	1.25	2.38	12 to 36	9 to 33
17,000	1.38	2.38	12 to 36	9 to 33
21,400	1.50	2.88	12 to 48	8 to 44
25,000	1.75	2.88	12 to 48	8 to 44
25,000	2.00	2.88	12 to 48	8 to 44
30,000	2.00	3.50	12 to 36	7 to 31
60,000	2.50	3.75	12 to 36	7 to 31
77,000	2.75	4.50	8 to 36	3 to 30
100,000	3.00	4.50	8 to 36	2 to 12
200,000	4.00	6.00	10 to 36	2 to 12

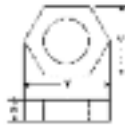

Hex Drives			
Corresponding Barrel Dia. (in)	U (in)	V (in)	W (in)
1.75	2.38	2.74	1.00
2.38	3.13	3.61	1.50
2.88	3.88	4.47	1.75
3.50	4.38	5.00	2.00
3.75	4.63	5.34	2.00
4.50	5.50	6.38	3.00
6.00	6.88	8.00	3.00

*Safe Working Load, in tension, provides a safety factor of approximately five to one.

Custom Ratchet Turnbuckles

Four-inch Shank Diameter, Jaw-and-Jaw Turnbuckle with Two-Hundred-Thousand Pound Working Load Limit (200,000 lb). (Load Limit is based on an approximate 5 to 1 safety factor.)

These turnbuckles help to hold large vessels in their moorings during the loading and unloading of cargo. Deck hands can easily release the lashings and allow the trip to begin without unnecessary difficulties.

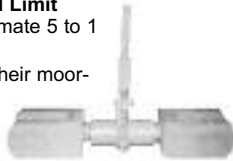

Four-inch Shank Diameter with Two-Hundred-Thousand Pound Working Load Limit (200,000 lb) and a Six-Foot Barrel. (Load Limit is based on an approximate 5 to 1 safety factor.)

These turnbuckles secure a fleet of thirty-story Gantry cranes at a Southeast Asia dock. Even under foul weather conditions, these turnbuckles help provide continuous operations.



Three-inch Shank Diameter with One-Hundred-Thousand Pound Working Load Limit (100,000 lb) and a Nine-Foot Barrel. (Load Limit is based on an approximate 5 to 1 safety factor.)

These turnbuckles bind twenty-three story Gantry cranes to the docks in New York City. Designed to be out of the way when not in use, they also speed up the loading and unloading cycles due to the ease of tensioning.



WINCH PRODUCTS

Winches provide a method for securing cargo on flatbed trailers, rail cars and other vehicles. Hanes Supply offers a wide variety of styles to ensure the correct winch is available for each application.

All winches are designed to meet the requirements of the Department of Transportation (DOT) and California Highway Patrol (CHP). We offer a broad range of winches for use with either 2", 3" or 4" web straps, cable, or a combination of both.

All winches are produced as right-hand models; left-hand models are available as a special order.

- **Standard** height winches are for bottom mounting only.
- **Low Profile** winches are designed for side mounting.
- **Storable** winches are for bottom mounting also and offer added capacity for storing up to 30' of webbing.

Weld-On Webbing Winches

Weld-on winches are designed to be permanently mounted in a fixed position.



Portable Webbing Winches

Portable winches allow flexibility of winch placement along the trailer side channel. (Portable winches are also available with set screws.)



Sliding Webbing Winches & Track

Sliding winches move easily in both directions for positioning in the track, but lock firmly in place when tension is applied to the webbing. Sliding winches must be used with winch track (part numbers 3606 and 3607). All sliding winches can also be welded in place for fixed application.

The design of the sliding winch track facilitates self-cleaning for maintenance-free operation. Winch track is for use with sliding winches only (part numbers 2820, 3820 and 5820). Track can be capped on ends or cross-bolted for security.



Storable Disc Webbing Winches

Disc winches are designed with large disc washers to guide and store the webbing into a straight roll, reducing strap wear. Disc winches can store up to 30' of webbing.



Load Securement

Hooks & Hitches

HOOKS & HITCHES

Spring Mounted Pintle Hooks

Do Not Weld or Modify Any Pintle Hook

- Recommended for off the road equipment - American made for use with drawbar eye dimensions
- 2-3/8" to 3" with 1-1/4" to 1-5/8" diameter
- To be mounted on a plate of at least 3/4" thick. For 25 ton and 15 ton.

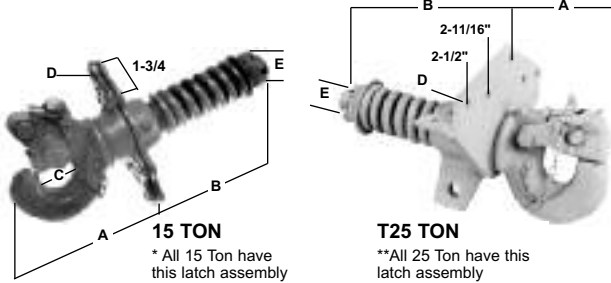

15 TON

* All 15 Ton have this latch assembly

T25 TON

**All 25 Ton have this latch assembly

Cat. No.	Part No.	Dimensions (in)					Max. Cap (lbs)			Wt. (lbs)
		A	B	C	D	E	Vertical Load	Gross Trailer Wt.		
2043100	*15 Ton	7-7/8	9-11/16	1-7/8	17/32	1-1/2	4,000	30,000	33-1/2	
2044101	**25 Ton	8-3/16	9-11/16	1-7/8	17/32	1-1/2	6,000	50,000	34-1/2	

Both styles feature a forged latch assembly, a heavy duty 2" shank through both brackets and manufactured by Wallace Forge.

T25 TON		Dimensions (in)					Max. Cap (lbs)			Wt. (lbs)
Cat. No.	Part No.	A	B	C	D	E	Vertical Load	Gross Trailer Wt.		
2045102	*T15 Ton	6-3/16	11-3/8	1-7/8	17/32	1-1/2	6,000	30,000	41	
2046103	**T25 Ton	6-1/2	11-3/8	1-7/8	17/32	1-1/2	6,000	50,000	42	

When mounting use all mounting holes with grade 8 bolts, lock nuts and flat washers. Do not weld to pintle hook.

Swivel Mounted Pintle Hooks

Recommended for off the Road equipment - Do Not Weld or Modify - American Made

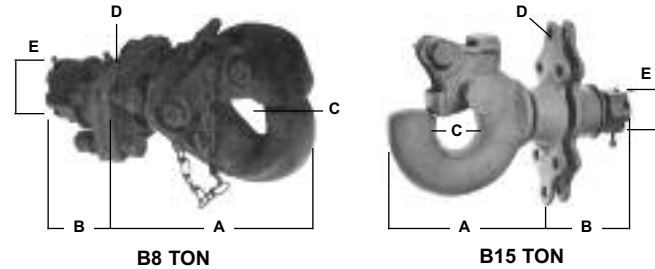

B8 TON

B15 TON

Cat. No.	Part No.	Dimensions (in)					Max. Cap (lbs)			Wt. (lbs)
		A	B	C	D	E	Vertical Load	Gross Trailer Wt.		
2047104	B8 Brackets	8-1/4	4	1-7/8	17/32	1-1/4	2,000	18,000	15	
2052109	NB8 No Brackets	8-1/4	4-3/8	1-7/8		1-1/4	2,000	18,000	10-1/4	

For use with drawbar eye dimensions 2" to 3" ID with 1-1/4" to 1-5/8" diameter
Specify when ordering military products due to dimensions differential.
B-8 MS-51335-1

B15 Ton		Dimensions (in)					Max. Cap (lbs)			Wt. (lbs)
Cat. No.	Part No.	A	B	C	D	E	Vertical Load	Gross Trailer Wt.		
2048105	*B15	11-1/2	4-3/8	1-7/8	17/32	1-1/2	3,000	30,000	27	
2049106	**B25	11-11/16	4-3/8	1-7/8	17/32	1-1/2	6,000	50,000	28	

For use with tow ring with 2-3/8" to 3" ID
• All 15 ton have this latch assembly See latch assembly for 25 ton

- continues -

Swivel Mounted Pintle Hooks (continued)

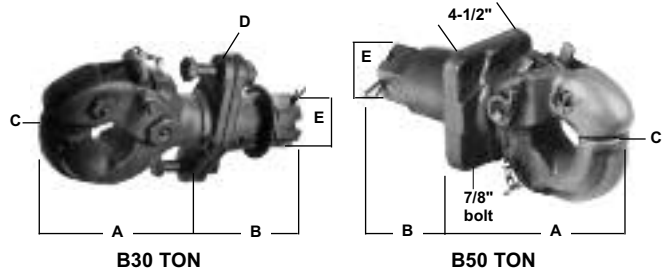

B30 TON

B50 TON

Cat. No.	Part No.	Dimensions (in)					Max. Cap (lbs)			Wt. (lbs)
		A	B	C	D	E	Vert. Load	Gross Trailer Wt.		
2050107	B30 Brackets	8-3/4	4-15/16	1-3/4	25/32	1-3/4	9,800	60,000	38	
2053110	NB30 No Brackets	7-3/4	5-7/8	1-3/4		1-3/4	9,800	60,000	28	

For use with drawbar eye dimensions with 3" ID with 1-5/8" diameter
Thread 1-3/4 - 12 UNF 2 Inch Shaft
Specify when ordering military products due to dimensions differential.
B-30 MS-51118-1

B50		Dimensions (in)					Max. Cap (lbs)			Wt. (lbs)
Cat. No.	Part No.	A	B	C	E	Vert. Load	Gross Trailer Wt.			
2051108	B50 Brackets	8-1/8	6-3/4	1-3/4	2-1/4	20,000	100,000	61		
2054111	NB50 No Brackets	6-5/8	8-3/8	1-3/4	2-1/4	20,000	100,000	41		

For use with drawbar eye dimensions 3" ID with 1-5/8" diameter
Specify when ordering military products due to dimensions differential.
B-50 MS-51117-1

Rigid Mounted Pintle Hooks

Do Not Weld or Modify Any Pintle Hook

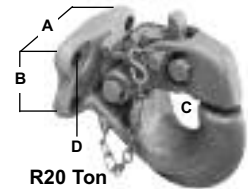

R20 TON

Cat. No.	Part No.	Dimensions (in)				Max. Cap. (lbs)			Wt. Ea. (lbs)
		A	B	C	D	Vertical Load	Gross Trailer Wt.		
1Q09331	R5-Ton	3-3/8	1-3/4	3/4	17/32	2,000	10,000	8	
2055112	R7 Ton	3-3/8	1-3/4	2	17/32	2,000	14,000	8-1/2	
2057115	R12 Ton	3-3/8	1-3/4	1-7/8	17/32	4,000	24,000	10-1/2	
2056113	R15 Ton	3-3/8	1-3/4	1-7/8	17/32	6,000	30,000	11	
2057114	R20 Ton	3-3/8	1-3/4	1-7/8	19/32	6,000	40,000	12-1/4	

Specify When Ordering Military Products Due To Dimensions Differential.
For use with Drawbar for following 2-3/8" to 3" ID

Dual Purpose Hitch

With dual locking assembly.

Do Not Weld or Modify

American Made

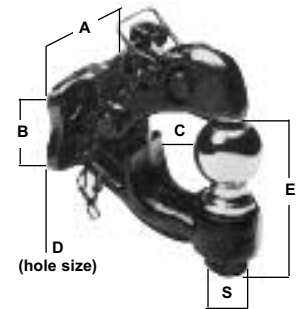

Cat. No.	Part No.	Dimensions (in)					Cap (lbs)				Wt. Ea. (lbs)
		A	B	C	D	E	S Shank Size	Ball Size	Ball Hitch	Pintle Hook	
2076118	DPH1780	3-3/8	1-3/4	2	17/32	4-3/16	1	1-7/8"	6000	8000	13
2077119	DPH2000	3-3/8	1-3/4	1-7/8	17/32	4-3/16	1	2"	10,000	16,000	13
2078120	DPH2516	3-3/8	1-3/4	1-7/8	17/32	4	1	2-5/16"	10,000	16,000	14
2331223	DPH50mm	3-3/8	1-3/4	1-7/8	17/32	4-3/16	1	50 mm	10,000	12,000	13

Patent 4434996 - Finish - Black/Chrome Ball
All DPH balls are interchangeable. Packaged - Individually
All Max. Vertical Load - 3,000 lb.
DPH balls are not a standard ball! Please call for replacement balls!

Hooks & Hitches/Flatbed Accessories

Ball Hitches

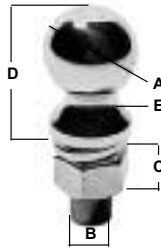

Chrome Ball Hitches								
Cat. No.	Part No.	Dimensions (in)					Max. Trailer Wt. (lbs)	Wt. Ea (lbs)
		A	B	C	D	E		
2324216	CBH1A	1-7/8	3/4	1-3/4	2-5/8	29/32	2,000	1-1/2
23257126	CBH2A	2	3/4	1-3/4	2-3/4	29/32	3,500	1-3/4
2325217	CBH3A	2	1	2	2-11/16	1-1/8	5,000	2
2326218	CBH4A	2-5/16	1-1/4	2-1/8	3-1/8	1-1/4	7,500	4-1/2
2326248	CBH5A	2-5/16	1	2	2-5/8	1-1/4	5,000	3
Long Shank								
2325215	CB1A	1-7/8	3/4	2-1/4	2-5/8	29/32	2,000	1-1/2
2325216	CB2A	2	3/4	2-1/4	2-3/4	29/32	3,500	1-3/4
High Strength Balls								
2358127	CBH8A	2	1	2-1/4	2-5/8	1-1/16	10,000	2-1/2
2325200	CBH9A	2-5/16	1	2-1/4	2-5/8	1-1/8	10,000	3
2325201	CBH10A	2-5/16	1-1/4	3	3-7/16	1-1/8	20,000	5
2325222	CB3A	2-5/16	1-1/4	2-5/8	3-3/8	1-21/64	30,000	5
2083163	BH5A	3	2	3-1/4	4-1/2	1-9/16	20,000	11-1/2

Standard D Rings

1040 Material
Specify Clip Style for Welding

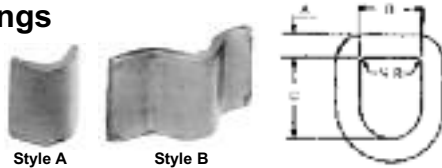

Cat. No.	Part No.	Dimensions (in)				Wt.	Swl.	Mbs	Clips
		A	B	C	D				
2327219	1/2	1/2	2-1/4	2-1/2	1	4,000	12,000	B	
2328220	5/8	5/8	3	3	2	6,000	19,000	A or B	
2022167	5/8	5/8	2-3/4	3-1/2	2-1/4	6,000	19,000	A or B	
2022168	3/4	3/4	3	3	4-1/4	9,000	27,000	A	
2329221	1	1	3	3	4-1/2	15,000	47,000	A	
2330222	1	1	3	4	5	15,000	47,000	A	

Tow Hooks

Do Not Weld or Modify

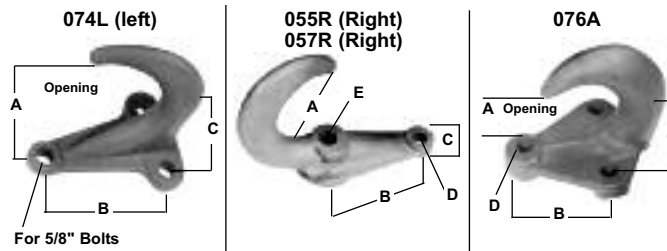

Cat. No.	Part No.	Dimensions (in)			Gross Trailer Wt.	Wt. Ea. (lbs)
		A	B	C		
2072137	074 R or L	2-1/2	4-1/2	2-3/4	17,000	4

Finish - Black American Made

Cat. No.	Part No.	Dimensions (in)					Gross Trailer Wt.	Wt. Ea. (lbs)
		A	B	C	D	E		
2316209	0-53 Extra Heavy	3	4-3/16	1-1/2	21/32	25/32	44,500	8
2074139	055	2-1/2	4-3/16	1-1/2	21/32	25/32	15,000	5
2073138	057	1-7/8	1-15/16	1-1/8	33/64	33/64	10,000	1-3/4

Finish - Black
0-53, 055, and 057 are available in Rights and Lefts

Cat. No.	Part No.	Dimension (in)				Gross Trailer Wt.	Wt. Ea. (lbs)
		A	B	C	D		
2075140	076A	2-3/8	2-1/2	2-13/16	5/8	20,000	4

Finish - Black American Made

Recessed Lashing Rings

Formed 1/8" steel pan encloses a forged ring.

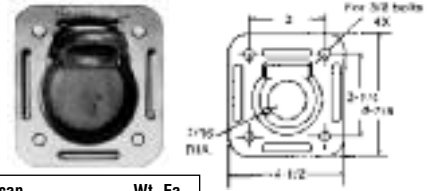

Cat. No.	Part No.	Rated cap. (lbs)	Finish	Wt. Ea. (lbs)
2383154	WF55801	5000	Zinc Plated	1.25

Truck Bed Tiedown Assemblies

3/8" Grade 70 Chain - Patent 3865048

- (1) When not in use, sets flush with truck floor bed.
- (2) Easy finger tip pull out.

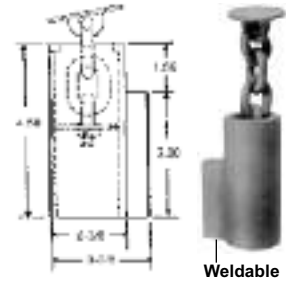

Cat. No.	Part No.	Rated Cap. (lbs)	Wt. Ea. (lbs)
2024169	Tiedown	5400	3-3/4

Use 2-3/8" drill for hole through floor.

Snapper Pins

Popular quick connect and disconnect pins.

Product Code	Pin Dia. (in)	Useable Length (A) - in	Clearance (B) - in	Wt. Ea. (oz)
2312801	1/4	1-3/4	1-1/2	1
2312802	5/16	2-1/4	1-5/8	2
2312803	3/8	1-1/4	1-1/2	2
2312804	3/8	2	1-1/2	2
2312807*	1/4	2-3/8	1-3/4	1
2312808	1/4	3	1-1/2	1
2312809	1/4	3-1/2	1-1/2	2

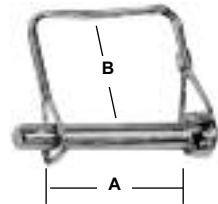

*Snapper Pin 2312807 Used on Pintle Hooks (1/4 x 2-3/4), except on 33 ton, 30 ton swivel and 50 ton.

FLATBED ACCESSORIES

Winch Bars

All winch bars feature a knurled non-slip handle, a tapered carbon steel nose piece for strength and easy operation. Combination bars have modified handles for use in tightening chain binders.

- 37030 - Standard Bar (Painted)
- 37031 - Standard Bar (Chrome Plated)
- 10032 - Combination Bar (Painted)
- 37033 - Combination Bar (Chrome Plated)

Corner Protectors

Corner protectors are designed to protect both strap and cargo. Plastic protectors feature a corner recess to protect the cargo edges. Rubber protectors conform to the load to evenly distribute corner loads.

NOTE: Straps must be threaded through captive corner protectors.



Web Protectors

Tough, abrasion resistant bulked nylon protective sleeving available in 300' rolls.

Also Available: CS20-012 -12" cut length. FE101A-012 -12" cut length.

Part No.	Fits Webbing Size (in)	Color	Grade
CS10	1	Black	Std.
CS20	1-3/4 or 2	Black	Std.
FE101A	1-3/4 or 2	Olive Drab	Heavy Duty
CS30	3	Black	Std.
CS40	4	Black	Std.



Load Securement

Flatbed Accessories/Straps

Floor Chain Tie-Down

Floor Chain Tie-Down is for use on steel frame flatbed trailers. It is a self-storing, convenient anchor point for securing loads and mounts flush with the trailer deck to prevent interference during loading or unloading.

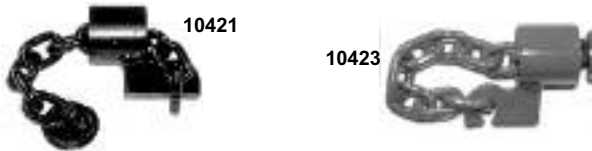

- Standard Grade 43
- WLL: 5,000 lbs.
- Weight: 3.2 lbs.
- Heavy Duty Grade 70
- WLL: 6,000 lbs.
- Weight: 3.2 lbs.

Welding Requirements for 10421 & 10423

Minimum welding requirements are: 1/4" fillet weld, around entire contact surface and 1/8" penetration.

Tarp Ties

These durable ties hold tarps securely and provide constant tension. Reinforced ends give added life. Tarp ties come with S-Hooks attached and are packaged 50 per box.

Also Available: 2200 - Spare S Hooks, 100 per box

Strap Part No.	Overall Length (in)	Installed Length (in)	Length Min. - Max. (in)	Wt. Per. 50 Pcs. (lbs)
CON 36000	10	14	15 - 19	10
CON 36020	15	19	21 - 30	12
CON 36040	21	25	28 - 42	15
CON 36060	31	35	39 - 62	19
CON 36080	41	45	50 - 82	25



Tarp Ties

STRAPS

Ratchet Straps

- Designed to handle most types of flatbed tie-down requirements. All straps have an 18" fixed end as standard, except for straps with 3705-2 and 3705-3 chain anchors which have a fixed end of 30". Special length fixed ends are available as a special order. All ratchet straps are labeled to meet CVSA guidelines, DOT regulations and WSTDA recommended standards. Alternate end hardware available.

2" Ratchet Strap w/802 Standard Handle and 2004 Webbing
10,000 lb. Breaking Strength

Strap Length	End Hardware	WLL
27'	1015	3,335 lbs.
30'	Flat Hook	1515 kgs.
27'	3705-2 Chain Anchor	3,335 lbs. 1515 kgs.



2" Ratchet Strap w/804 Wide Handle and 2004 Webbing
10,000 lb. Breaking Strength

Strap Length	End Hardware	WLL
27'	1015	3,335 lbs.
30'	Flat Hook	1515 kgs.
27'	3705-2 Chain Anchor	3,335 lbs. 1515 kgs.
27'	1006 Wire Hook	3,335 lbs. 1515 kgs.

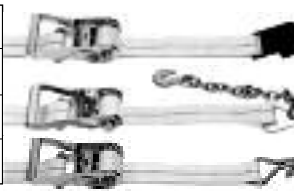

2" Ratchet Strap w/803 Long Wide Handle and 2004 Webbing
10,000 lb. Breaking Strength

Strap Length	End Hardware	WLL
27'	1015	3,335 lbs.
30'	Flat Hook	1515 kgs.



3" Ratchet Strap w/806 Long Handle and 3004 Webbing

Strap Length	End Hardware	WLL
27'	1021-3 Flat Hook	5,000 lbs. 2270 kgs.
30'		
15,000 lb. Breaking Strength		
Strap Length	End Hardware	WLL
27'	3705-3 Chain Anchor	5,400 lbs. 2450 kgs.
30'		
27'	3704 Grab Hook	5,400 lbs. 2450 kgs.
30'		
16,200 lb. Breaking Strength		

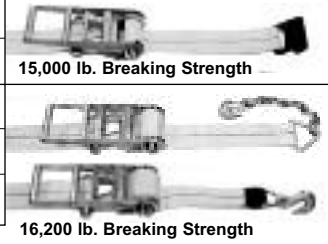

4" Ratchet Strap w/808 Long Handle and 4004 Webbing

Strap Length	End Hardware	WLL
27'	1021-3 Flat Hook	5,000 lbs. 2270 kgs.
30'		
15,000 lb. Breaking Strength		
Strap Length	End Hardware	WLL
27'	1016 Wire Hook	6,600 lbs. 2995 kgs.
30'		
20,000 lb. Breaking Strength		

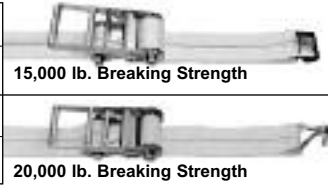

Strap-All™ 1" Straps - We offer a full line of one-inch ratchet and utility straps. These versatile tie-downs can be used on pick-up trucks, car top racks, boat trailers or anywhere a light duty tie-down is needed.

Ratchet Strap with 800 Ratchet, Wire Hooks and D Rings

- Breaking Strength: 2,500 lbs./1135 kgs.
- WLL: 835 lbs./380 kgs.

711681/45 - 16'



Ratchet Strap with 800 Ratchet and Vinyl Coated S Hooks

- Breaking Strength: 1,200 lbs.
- WLL: 400 lbs.

710987 - 9'



Utility Strap with 605 Cam Buckle and Vinyl Coated S Hooks

- Breaking Strength: 1,200 lbs.
- WLL: 400 lbs.

750687 - 6'



Utility Strap with 605 Cam Buckle and Wire Hooks

- Breaking Strength: 1,200 lbs.
- WLL: 400 lbs.

751281 - 12'



Utility Strap with 810 Ratchet and Vinyl Coated S Hooks

- Breaking Strength: 1,200 lbs.
- WLL: 400 lbs.

760987 - 9'



7
Load Securement

Straps/Tracks/Bars

Logistic Straps - Designed to take care of most interior van loading requirements. All straps have a 4' fixed end as standard. Adjustable ends are sewn captivated.

2" Logistic Straps w/811 Ratchet Buckle and 4900 Webbing

Strap Length (ft)	End Hardware	Assy. Breaking Strength	WLL
12	Series E, A		
16	FE8306-1 Spring Fitting	3,000 lbs. 1360 kgs.	1,000 lbs. 455 kgs.
20			
12	Series E, A		
16	43020-1 3-Piece Fitting	3,000 lbs. 1360 kgs.	1,000 lbs. 455 kgs.
20			
12	Series F		
16	1831 Butterfly Fitting	1,250 lbs. 570 kgs.	420 lbs. 195 kgs.
20			
12	Series F		
16	FE8427-1 Plate Trailer Hook	2,200 lbs. 1000 kgs.	735 kgs. 335 kgs.
20			

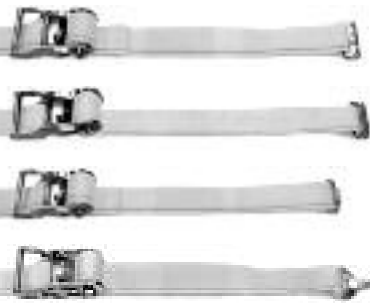

TRACK

Logistic Track - We offer a complete line of series E, A and F track designed to provide the attachment point for a wide variety of interior van cargo control systems.

Logistic Track will accept all end fittings, sockets, beams and bars designed for use in series E, A and F track.

Series E and A track are offered standard in 10' length with special lengths available upon request. (Call Hanes Supply for complete details) Tracks can be attached with screws, rivets or by welding. Specific fastener size and or mounting method should be determined by the vehicle manufacturer or a qualified installer. Care shall be taken to ensure that installation environments and materials do not create a potential for corrosion.

Series E Track Horizontal

- Material: High strength steel; 12 gauge
- Min. Yield: 50,000 psi.
- Finish: 43002 - Paint; FE718-01 - Galv.
- * Also Available: 43002-060 Length: 5ft.
- Weight: 16.6 lbs.
- Length: 10 ft.



Series E Track Vertical

- Material: High strength steel; 11 gauge
- Min. Yield: 50,000 psi.
- Finish: Paint
- Weight: 14.2 lbs
- Length: 10 ft.

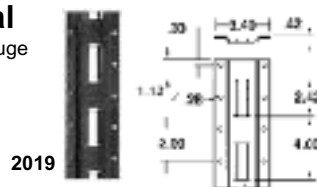

Heavy Duty Series A Track Horizontal

- Material: High strength steel; 11 gauge
- Min. Yield: 50,000 psi.
- Length: 10 ft.
- Finish: Paint
- Weight: 21.1 lbs

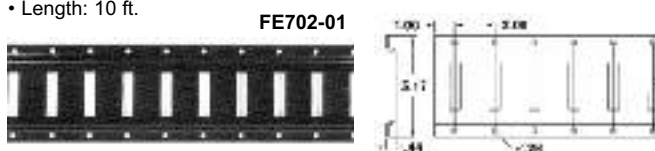

Aluminum Series A Track Horizontal

- Material: Aluminum
- Min. Yield: 35,000 psi.
- Finish: Natural
- Weight: 8.3 lbs.
- Length: 10 ft.



BARS

Series F & SAF-T-Lok Bars - Saf-T-Lok bars are designed for economy and ease of operation. These bars are offered in galvanized steel tubing and feature a steel rack, a heavy duty steel handle and a cast aluminum painted housing. Molded rubber fixed feet are welded to both ends of the steel tubing and grip firmly to trailer walls, yet won't scuff and will remain pliable even at low temperatures. The handle and trigger release are easy to operate even with gloved hands.

Steel Tube w/Welded Foot Saf-T-Lok Bar

- 10082 • Adjusts from: 89" to 105" • Weight: 11.8 lbs.



Steel Tube w/Pivoting Foot Saf-T-Lok Bar

- 10085 • Adjusts from: 89" to 105" • Weight: 11.8 lbs.



Aluminum Tube w/Pivoting Foot Saf-T-Lok Bars

- 10088 • Adjusts from: 89" to 105" • Weight: 8.3 lbs.



Jack Bars

Round Galvanized One-Piece Jack Bars

The JB 102 jack bars are constructed of round galvanized steel tubing.



- JB102 - Adjusts from: 86" to 104" • Weight: 12.3 lbs.

Square Galvanized One-Piece Jack Bars

The JB 103 square jack bars are constructed of heavy wall galvanized steel tubing for increased strength and durability.



- JB103 - Adjusts from: 86" to 104" • Weight: 15.9 lbs.

NOTE: Cargo bars do not have load ratings due to varying conditions of trailer side-walls. Cargo hoop set available for use with all jack bars.

Load Securement

Cargo Nets/Hardware

CARGO NETS:

Cargo Nets are made to each customer's exacting specifications and provide durable and reliable load securement or separation for flatbed, interior van trailer and a variety of other cargo restraint applications; therefore, no "standard" configurations shall be inventoried.

Every cargo net is manufactured consistently and efficiently to ensure optimum quality and customer satisfaction.

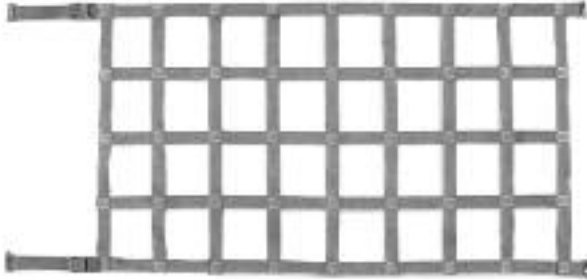

Common Hardware Options for Cargo Nets



2" Wide Handle Ratchet Buckle

- Breaking Strength: 11,000 lbs. • Weight: 2.46 lbs.
- Working Load Limit: 3,670 lbs.

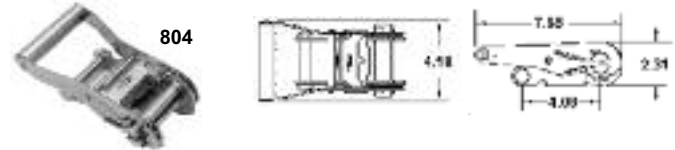

3" Long Handle Ratchet Buckle

- Breaking Strength: 17,000 lbs. • Weight: 7.05 lbs.
- Working Load Limit: 5,670 lbs.



4" Long Handle Ratchet Buckle

- Breaking Strength: 24,000 lbs. • Weight: 7.94 lbs.
- Working Load Limit: 8,000 lbs.

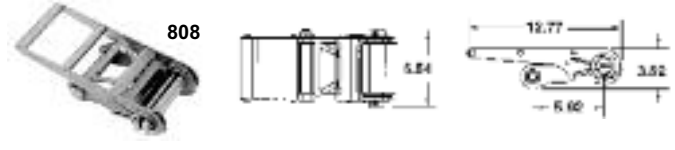

1" Cam Buckle

- Breaking Strength: 2,500 lbs. • Weight: 0.44 lbs.
- Working Load Limit: 835 lbs. • Webbing: 30100 or FE174

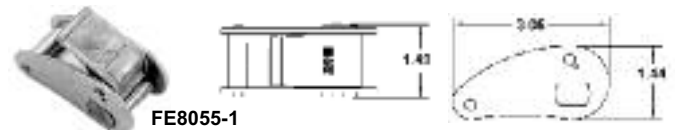

1" Flat Hook

- Breaking Strength: 700 lbs. • Weight: 0.04 lbs.
- Working Load Limit: 235 lbs.



2" Flat Hook

- Breaking Strength: 5,500 lbs. • Weight: 0.44 lbs.
- Working Load Limit: 1,835 lbs.



2" Flat Hook

- Breaking Strength: 10,000 lbs. • Weight: 0.73 lbs.
- Working Load Limit: 3,335 lbs.

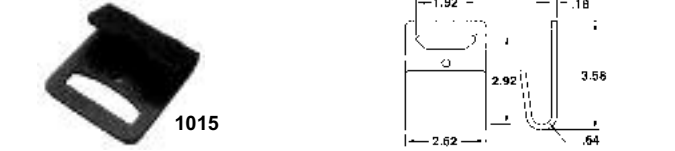

HARDWARE

Ratchet Buckles - Hanes Supply offers a complete line of ratchet buckles to handle all types of tie-down applications. All buckles are designed for strength, durability and ease of operation. Ratchet buckles are available for webbing widths 1" to 4" with various handle configurations to satisfy user preferences.

Operating Instructions: To tension: Pull webbing through reel bars to eliminate slack. Operate handle back and forth until webbing is properly tensioned. Reel bars must have at least two wraps of webbing to ensure no slippage. Wrench drive models require the use of a socket or wrench.

To release: Pull handle pawl back and rotate handle over center to full open position.

1" Wide Handle Ratchet Buckle

- Breaking Strength: 3,300 lbs. • Weight: 0.77 lbs.
- Working Load Limit: 1,100 lbs.

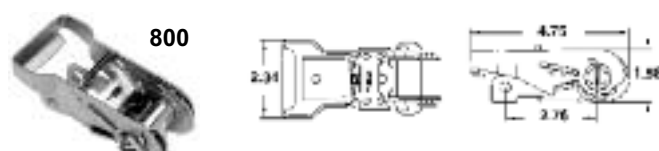

2" Standard Handle Ratchet Buckle

- Breaking Strength: 11,000 lbs. • Weight: 2.34 lbs.
- Working Load Limit: 3,670 lbs.

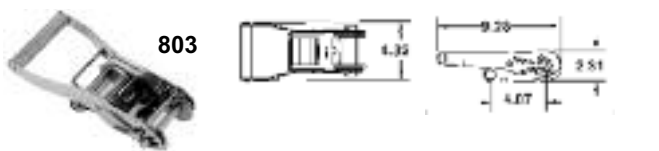

Hardware/Wire Hooks & Chain Attachments

4" Flat Hook

- Breaking Strength: 15,000 lbs. • Weight: 1.06 lbs.
- Working Load Limit: 5,000 lbs.

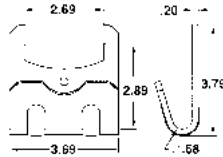

1" Narrow Hook

- Breaking Strength: 2,500 lbs. • Weight: 0.11 lbs.
- Working Load Limit: 835 lbs.

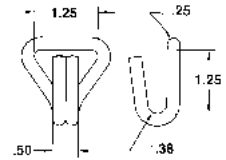

1" Snap Hook

- Breaking Strength: 5,500 lbs. • Weight: 0.20 lbs.
- Working Load Limit: 1,835 lbs.

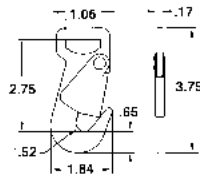

1" Hook and Keeper

- Breaking Strength: 9,000 lbs. • Weight: 0.25 lbs.
- Working Load Limit: 3,000 lbs.

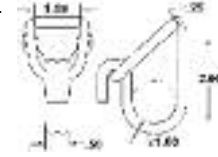

2" Snap Hook

- Breaking Strength: 6,000 lbs. • Weight: 0.41 lbs.
- Working Load Limit: 2,000 lbs.

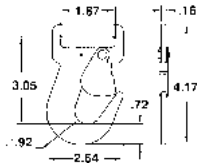

2" Narrow Hook

- Breaking Strength: 10,000 lbs. • Weight: 0.58 lbs.
- Working Load Limit: 3,335 lbs.

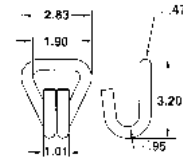

2" Snap Hook

- Breaking Strength: 10,000 lbs. • Weight: 0.61 lbs.
- Working Load Limit: 3,335 lbs.

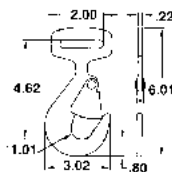

2" Narrow Hook

- Breaking Strength: 5,000 lbs. • Weight: 0.37 lbs.
- Working Load Limit: 1,670 lbs.

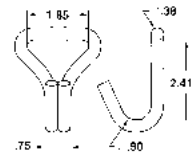

2" Twisted Snap Hook

- Breaking Strength: 10,000 lbs. • Weight: 0.61 lbs.
- Working Load Limit: 3,335 lbs.

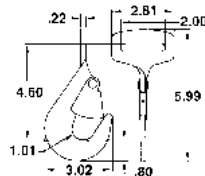

3" Narrow Hook

- Breaking Strength: 22,000 lbs. • Weight: 1.39 lbs.
- Working Load Limit: 7,333 lbs.

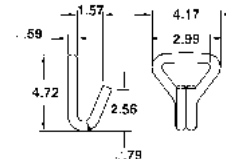

3/8" Grab Hook Assembly

- Breaking Strength: 16,200 lbs. • Weight: 1.22 lbs.
- Working Load Limit: 5,400 lbs.

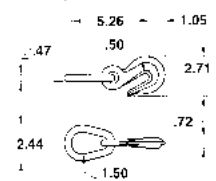

WIRE HOOKS & CHAIN ATTACHMENTS:

1" Vinyl Coated S Hook

- Breaking Strength: 1,200 lbs. • Weight: 0.30 lbs.
- Working Load Limit: 400 lbs.

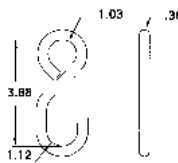

1" Vinyl Coated S Hook

- Breaking Strength: 500 lbs. • Weight: 0.14 lbs.
- Working Load Limit: 170 lbs.

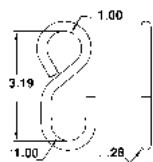

18" Chain Anchor

- Breaking Strength: 16,200 lbs. • Weight: 2.89 lbs.
- Working Load Limit: 5,400 lbs.

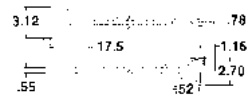

Load Securement

Wire Hooks & Chain Attachments/Specialty Hardware

Cluster Hook RTJ

- Breaking Strength: 11,600 lbs. • Weight: 2.23 lbs.
- Working Load Limit: 3,900 lbs.
- R-Hook (GM & Chrysler), T-Hook (Ford), J-Hook (Import)

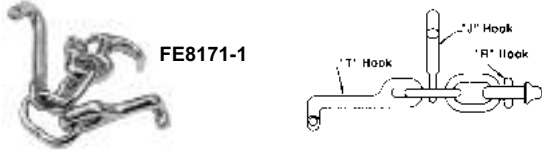

1" D-Ring

- Breaking Strength: 5,000 lbs.
- Weight: 0.07 lbs.
- Working Load Limit: 1,670 lbs.



2" Flat Delta Ring

- Breaking Strength: 10,000 lbs.
- Weight: 0.29 lbs.
- Working Load Limit: 3,335 lbs.

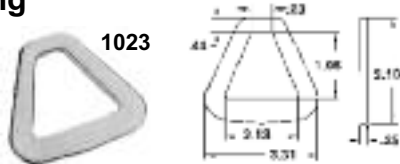

4" Delta Ring

- Breaking Strength: 20,000 lbs.
- Weight: 1.36 lbs.
- Working Load Limit: 6,670 lbs.

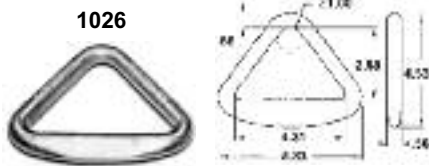

Logistic Track Fittings

Series E/A Spring Loaded Fitting

- Breaking Strength: 4,500 lbs. • Weight: 0.21 lbs.
- Working Load Limit: 1,500 lbs.

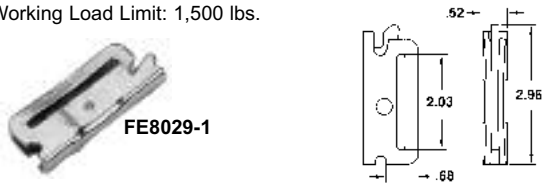

SPECIALTY HARDWARE

Black Pan Fitting with Ring & Stud

- 0° Ring Vertical Breaking Strength: 3,000 lbs./1360 kgs.
- 45° Ring Pull Angle Breaking Strength: 2,500 lbs./1135 kgs.
- 0° Stud Vertical Breaking Strength: 5,000 lbs./2270 kgs.
- 45° Stud Pull Angle Breaking Strength: 2,000 lbs./910 kgs.
- Weight: .32 lbs.

