

SECTION 18
Ladders

ALUMINUM	Order Pickers	18-3	PLANKS, SCAFFOLDING	Aluminum.....	18-9, 18-11, 18-14, 18-17
Ladder	18-2, 18-7-8, 18-14	Pail Shelf	18-11	Decorator	18-9, 18-14
Scaffold Plank.....	18-9, 18-11, 18-14, 18-17	Pivot-In-Place	18-3	Extension.....	18-11
Stages	18-9, 18-14	Planks	18-9, 18-11, 18-14	Guard Rail	18-9, 18-12, 18-14, 18-16
BAKER	Platform	18-6, 18-8, 18-10	PLATFORM	Scaffolding.....	18-9, 18-11, 18-14, 18-17
Scaffolding	18-12, 18-15-16	Platform, Rolling Work	18-12, 18-15-16	Stage.....	18-9, 18-11, 18-14
CABLE HOOKS	18-11, 18-17	Pole Grip	18-11	Toeboard.....	18-14, 18-16-17
CAGE	Work.....	18-11	Preservative.....	Wood.....	18-11, 18-16-17
Work.....	18-18	Rolling	18-1-3	PLATFORM	
CART	Drywall	18-11	Ladder	18-6, 18-8, 18-10	
Drywall	18-12	Roof Hook	Lifts	18-3-4	
CLAMP	Parapet.....	18-11	Rolling Work.....	18-12, 18-16	
Parapet.....	18-19	Scaffolding Entry	POLE		
CORNICE HOOKS	18-19	Scaffolding, Powered	Grip.....	18-11	
CROSSOVER	Ladders	18-18-19	Lash.....	18-11	
Ladders	18-4	Scissor Lift.....	RAIL WEAR SLEEVES	18-11	
DOCK	Ladders	18-3	ROLLING LADDERS	18-1-3	
Ladders	18-3	Shelf.....	ROOF		
DOUBLE ENTRY	Ladders	18-6, 18-8	Hook, Ladder.....	18-11	
Ladders	18-5-7, 18-10	Shoes	SCAFFOLDING		
DRYWALL	Cart	18-11	Base Section.....	18-15-16	
Cart	18-12	Single	Baker.....	18-12, 18-15-16	
EXTENSION	Ladders	18-14	Decking	18-11, 18-16-17	
Ladders	18-6-8, 18-10-11, 18-13-14	Stages	Guardrail.....	18-9, 18-12, 18-14, 18-16	
FIBERGLASS	Ladder	18-9, 18-14	Outriggers.....	18-12, 18-16, 18-19	
Ladder	18-5-7, 18-13, 18-15	Stages, Planking	Planking	18-9, 18-11, 18-14, 18-17	
FORK LIFT	Platforms	18-9, 18-11, 18-14	Sections	18-15-16	
Platforms	18-4	Step Accessories	Stages	18-9, 18-14	
GUARD RAIL	Scaffolding.....	18-11	Stairways.....	18-16	
Scaffolding.....	18-9, 18-12, 18-14, 18-16	Step Ladders	Toe Board	18-12, 18-14, 18-16-17	
HOOKS	Cable.....	18-5-10	SCAFFOLDING, POWERED		
Cable.....	18-11, 18-17	Step Stools	Accessories.....	18-19	
Cornice Hooks.....	18-19	Stock Picking.....	Corner Unit.....	18-18	
Roof.....	18-11	Swivel Shoes.....	Cornice Hooks.....	18-19	
HYDRAULIC	Roof.....	18-11	Counter Weights	18-19	
Platform Lift	18-3	Tank-Top Lift	Guard Rail Support	18-19	
JACKS	Ladder	18-4	I-Beam Assembly	18-19	
Ladder	18-11	Tilt and Roll	Outriggers, Rolling	18-19	
LADDER	Aluminum.....	18-2	Roller Bumpers	18-19	
Aluminum.....	18-2, 18-7-8, 18-14	Trestle	Speed Winder.....	18-19	
Baker Scaffolding.....	18-12, 18-15-16	18-11, 18-13	Window Washers Set Up	18-18	
Cable Hooks.....	18-11, 18-17	Tripod	Work Cages	18-18	
Combination	18-7	18-6, 18-10	SCISSOR LIFT		
Crossover	18-4	Twin Front	Lift Platform	18-3	
Dock	18-3	18-5-7, 18-10	SHELF		
Double Entry	18-5-7, 18-10	V-Rung	Ladders	18-6, 18-8	
Extension	18-6-8, 18-10-11, 18-13-14	18-17	SHOES		
Extension Ladders	Accessories	18-1-4	Ladder	18-11	
Accessories	18-11, 18-17	Warehouse Ladders	SINGLE		
Fiberglass	18-5-7, 18-13, 18-15	18-11	Ladders	18-14	
Fold-N-Store	18-2	Wear Sleeves	STAGES		
Jacks	18-11	18-11	Aluminum.....	18-9, 18-14	
Leveler.....	18-11	Wheel Spurs	Planking.....	18-9, 18-11, 18-14, 18-17	
Lift Platforms	18-3-4	18-11	STAND		
Manhole	18-7	Wood Preservative	Work.....	18-6, 18-8	
Mezzanine.....	18-3	Wooden	STAND OFF SURFACE PROTECTORS		
Mitts.....	18-11, 18-17	18-9-11, 18-15	Ladder	18-11, 18-17	
Mud Blocks.....	18-11	Work Stand			
		18-6, 18-8			
		LEG LEVELER			
		18-11			
		LIFT			
		Platforms			
		18-3-4			
		MAN LIFT			
		Platforms			
		18-3-4			
		MANHOLE			
		Ladders			
		18-7			
		MEZZANINE			
		Ladders			
		18-3			
		MOBILE			
		Lift Platforms			
		18-3-4			
		MRO MAINTENANCE			
		Platform Lift			
		18-3			
		ORDER PICKERS			
		Lift Platforms			
		18-3			
		OUTRIGGERS			
		Scaffolding			
		18-12, 18-16, 18-19			
		PAIL SHELF, LADDERS			
		18-11			
		PARAPET CLAMPS			
		18-19			
		PICK			
		Aluminum.....			
		18-9, 18-14			
		PIVOT-IN-PLACE			
		Ladders			
		18-3			

– continues –

SECTION INDEX

SECTION 18
Ladders

STEP		TWIN FRONT	
Ladders	18-5-10	Ladders	18-5-7, 18-10
Stools	18-15	V-RUNG	
STOCK PICKING		Ladders	18-17
Ladders	18-1	WAREHOUSE	
STOOLS		Ladders	18-1-4
Step	18-15	WHEEL SPURS	
TANK-TOP LIFT		Ladders	18-11
Ladders	18-4	WINDOW WASHER LIFT	18-18-19
TILT AND ROLL		WOOD	
Ladders	18-2	Ladders	18-9-11, 18-15
TRESTLE		Preservative, Ladders	18-11
Ladders	18-11, 18-13	WORK	
TRIPOD		Cages	18-18
Ladders	18-6, 18-10	Stand	18-6, 18-8

Ballymore/Garlin Ladders

Standard Rolling Ladders with Spring Loaded Casters

- Mounted on four spring loaded swivel casters that retract under user's weight
- Working heights up to 12'
- Pyramid design centers user's weight
- 7" deep steps with 10" deep top step
- Comes standard with expanded metal tread, optional treads available
- All 1-4 step ladders without handrails and 2-3 step ladders with handrails ship setup
- 4-7 ladders are standard knocked-down, for setup specify (SU) at no extra charge
- Corrosion resistant deep gray enamel finish
- 300 lbs. load rating
- Built to OSHA and ANSI standards
- CAL OSHA available



Model No.	Ht. (in) Top Step	Ht. (in) Overall	No. of Steps	Base Width (in)	Base Depth (in)	Wt. (lbs)
Narrow 1 to 4 Step Ladders Without Handrails:						
118*	12	12	1	18	16	18
218*	19	19	2	20	19	22
318*	28.5	28.5	3	20	25	29
418	38	38	4	20	31	35
Wide 1 to 4 Step Ladders Without Handrails:						
126*	12	12	1	26	16	20
226*	19	19	2	30	19	34
326*	28.5	28.5	3	30	25	38
426	38	38	4	30	31	48
Narrow 2 to 7 Step Ladders With 30" Handrails and Spring Loaded Casters:						
H218*	19	49	2	20	19	30
H318	28.5	58.5	3	20	25	36
H418	38	68	4	20	31	46
H518	47.5	77.5	5	20	37	55
HM618†	57	87	6	24	43	63
HN718†	66.5	96.5	7	24	49	72
Wide 2 to 7 Step Ladders With 30" Handrails and Spring Loaded Casters:						
H226	19	49	2	30	19	37
H326	28.5	58.5	3	30	25	46
H426	38	68	4	30	31	62
H526	47.5	77.5	5	30	37	75
H626	57	87	6	30	43	83
H726	66.5	96.5	7	30	49	93

Options:
2-3 step ladders with 20" DTS
2-3 step ladders with 30" DTS

M-2000 Series Rolling Safety Ladders

- 350 lbs. load rating
- All ladders are provided with a lockstep and two rigid 4 casters in back
- Easy operating lockstep with foot pedal
- 7" deep steps with 14" deep top step and a 10" rise
- Ladders come knocked-down standard for freight savings, for optional setup ladder specify (SU)
- Steps are standard expanded metal (X)
Optional R - steel with abrasive mat
Optional G - serrated grating
- Composed of rigid 1" OD tubing
- Standard finish is deep gray enamel paint
- Built to OSHA and ANSI standards
- CAL OSHA available



Model No.	Top Step Depth (in)	Height (in) Top Step	Height (in) Overall	No. of Steps	Base Width (in)	Base Depth (in)	Wt. (lbs)
Narrow 6 to 7 Stop Ladders With Lock Steps & 30" Handrails							
062414X	14	60	90	6	24	48	80
072414X	14	70	100	7	24	54	89
062421X	21	60	90	6	24	48	91
072421X	21	70	100	7	24	54	101
062428X	28	60	90	6	24	48	102
072428X	28	70	100	7	24	54	112
Wide 6 to 12 Stop Ladders with Lock Steps & 30" Handrails							
063014X	-	60	90	6	30	48	122
073014X	-	70	100	7	30	54	143
083214X	-	80	110	8	32	60	160
093214X	-	90	120	9	32	67	175
103214X	-	100	130	10	32	73	193
113214X	-	110	140	11	32	79	205
123214X	-	120	150	12	32	86	220

* 21" and 28" deep top steps to replace the standard 14"

M-2000 Series Rolling Safety Ladders (continued)

Model No.	Ht. (in) Top Step	Ht. (in) Overall	No. of Steps	Base Width (in)	Base Depth (in)	Wt. (lbs)
Wide 6 to 12 Step Ladders with 21" DTS with Lockstep						
063021X	60	90	6	30	55	132
073021X	70	100	7	30	61	153
083221X	80	110	8	32	68	170
093221X	90	120	9	32	74	185
103221X	100	130	10	32	80	203
113221X	110	140	11	32	87	215
123221X	120	150	12	32	93	237
Wide 6 to 12 Step Ladders with 28" DTS with Lockstep						
063028X	60	90	6	30	62	145
073028X	70	100	7	30	68	163
083228X	80	110	8	32	75	183
093228X	90	120	9	32	81	196
103228X	100	130	10	32	87	212
113228X	110	140	11	32	94	227
123228X	120	150	12	32	100*	249

* Must ship knocked-down due to size

13 - 15 Step Ladders

- Ladders come knocked down standard for freight savings, for optional setup ladder specify (SU)
- Steps are standard expanded metal (X)
Optional R - steel with abrasive mat
Optional G - serrated grating
- All ladders are provided with a lockstep and two rigid 4" casters in back
- 7" deep steps with 10" deep top step and a 9.5" rise
- Composed of rigid 1" OD tubing
- Standard finish is deep gray enamel finish
- 300 lbs. load rating
- Built to OSHA and ANSI standards
- CAL OSHA available



20" Deep Top Step Shown (13-15 step ladders with DTS are supplied with 4" toeboards)

Model No.	Ht. (in) Top Step	Ht. (in) Overall	No. of Steps	Base Width (in)	Base Depth (in)	Wt. (lbs)
13 to 15 Step Ladders With 36" Handrail & 36" Base Width						
H1326	123.5	159.5	13	36	82	216
H1426	133	169	14	36	88	229
H1526	142.5	178.5	15	36	94	242
16 to 20 steps call for specification and pricing						
13 to 15 Step Ladders With 20" & 30" DTS with lockstep						
H132620	123.5	159.5	13	36	92	226
H142620	133	169	14*	36	98	239
H152620	142.5	172.5	15*	36	104	252
H132630	123.5	159.5	13	36	102	236
H142630	133	169	14*	36	108	249
H152630	142.5	172.5	15*	36	114	262

* Must ship knocked-down due to size

Stock Picking Ladders

- Combines the benefits of a rolling safety ladder and a stock picking cart
- 24" wide expanded metal steps, top step is 20" x 24"
- Sturdy, 24" x 24" shelves
- 2 shelves on 6-7 step models
- 3 shelves on 8-12 step models
- Combined 600 lbs. load rating - 300 lbs. for the ladder and 300 lbs. for the storage shelves
- Standard finish is deep gray enamel paint
- Complies to OSHA and ANSI standards 30" handrails

Options: Folding 7" x 24" tray mounted on top rail

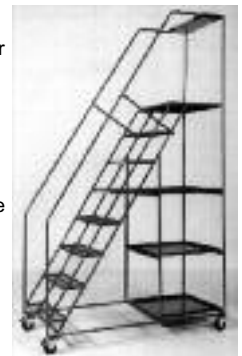

Shown with optional folding tray

Model No.	Ht. (in) Top Step	Ht. (in) Overall	No. of Steps	Base Width (in)	Base Depth (in)	Wt. (lbs)
SPL-6	57	87	6	30	50	165
SPL-7	66.5	96.5	7	30	56	175
SPL-8	76	106	8	30	62	185
SPL-9	85.5	115.5	9	30	68	195
SPL-10	95	125	10	30	74	205
SPL-11	104.5	134.5	11	30	80	215
SPL-12	114	144	12	30	86	225

Ladders

Ballymore/Garlin Ladders

Heavy Duty Stairway Slope Ladders

- HEAVY DUTY - RUGGED 400 lbs. load capacity
- Unique 48° stairway slope (for easy forward ascent or descent)
- 24" wide solid steel steps with abrasive mats (R)
Optional X - expanded metal
Optional G - serrated grating
- Top step is 14" deep for additional comfort, intermediate steps are 10" deep with 9" run
- Easy operating lockstep secures ladder to the floor
- Standard finish is deep gray enamel paint
- Exceeds OSHA and ANSI standards
- CAL OSHA option available
- Ladder ships setup unless noted



Options:

- 28" double deep top step
- One-position locking swivel casters on rear
- Expanded metal tread (X) per step
- Serrated grating tread (G) per step
- Models 5-10 knocked down
- Hand lever for lockstep
- Snap chain for rear exit
- Snap chain for side exit
- 10" x 24" folding shelf on rear guardrail

Model No.	Ht. (in) Top Step	Ht. (in) Overall	No. of Steps	Base Width (in)	Base Depth (in)	Wt. (lbs)
HDS-5-R	50	80	5	30	50	132
HDS-6-R	60	90	6	30	59	152
HDS-7-R	70	100	7	30	68	178
HDS-8-R	80	110	8	30	77	204
HDS-9-R	90	120	9	30	86	227
HDS-10-R	100	130	10	30	95	245
HDS-11-R	110	140	11†	30	104	278
HDS-12-R	120	150	12†	30	113	297

† Must ship knocked-down due to size.

Aluminum Rolling Safety Ladders

- Ideal for use in banks, libraries, schools, hospitals, and offices, as well as pharmaceutical and food applications
- Lightweight design provides easy mobility
- Mounted on spring loaded casters
- Solid, slip-resistant extrusion steps with reinforced nosing
- Corrosion resistant and easy to clean
- Non-magnetic and non-sparking
- Intermediate steps are 7" deep while top step is 10" deep
- Ladders come with aluminum mill finish
- 300 lbs. load rating
- Built to OSHA and ANSI standards
- Cal OSHA available



Options:

- Removable hanging 10" x 24" shelf
- 20" Deep top step
- Serrated grating aluminum steps
- Alternate caster arrangements

Model No.	Ht. (in) Top Step	Ht. (in) Overall	No. of Steps	Base Width (in)	Base Depth (in)	Wt. (lbs)
2 to 4 Step Ladders without rails						
A2S*	19	19	2	20	19	15
A3S*	28.5	28.5	3	20	25	20
A4S	38	38	4	20	31	29
A2S30*	19	19	2	30	19	22
A3S30	28.5	28.5	3	30	25	28
A4S30	38	38	4	30	31	35
3 to 7 Step Ladders with 30" handrails						
A3SH	28.5	58.5	3	20	25	27
A4SH	38	68	4	20	31	34
A3SH30	28.5	58.5	3	30	25	34
A4SH30	38	68	4	30	31	41
A5SH30	47.5	77.5	5	30	37	49
A6SH30	57	87	6	30	43	60
A7SH30	66.5	96.5	7	30	49	67

* Eligible for UPS

Stainless Steel Ladders

- Ideal for wash-down or outdoor applications
 - Heavy duty serrated grating steps are slip resistant and self cleaning
 - Ladder rolls on four spring loaded swivel casters
- Note: casters and springs are not stainless steel
- Ladders are provided with stainless steel mill finish
 - 300 lbs. load rating
 - Built to OSHA and ANSI standards
 - CAL OSHA available



Model No.	Ht. (in) Top Step	Ht. (in) Overall	No. of Steps	Base Width (in)	Base Depth (in)	Wt. (lbs)	Model No.	Base Width (in)	Wt. (lbs)
2 to 4 step ladders without rails									
SS2SG	19	19	2	20	19	23	SS2S30G	30	38
SS3SG	28.5	28.5	3	20	25	34	SS3S30G	30	43
SS4SG	38	38	4	20	31	41	SS4S30G	30	54
2 to 7 step ladders With 30" handrails									
SS2SHG	19	49	2	20	19	37	SS2SH30G	30	44
SS3SHG	28.5	58.5	3	20	25	44	SS3SH30G	30	54
SS4SHG	38	68	4	20	31	55	SS4SH30G	30	70
SS5SHG	47.5	77.5	5	20	37	65	SS5SH30G	30	85
SS6SHG	57	87	6	24	43	77	SS6SH30G	30	97
SS7SHG	66.5	96.5	7	24	49	89	SS7SH30G	30	109

Fold-N-Store Ladders

- Ladder can be easily folded for storage or transportation and offers tilt and roll mobility when setup
- Two 10" diameter rubber wheels on rear of ladder, with rubber tips on front legs to secure ladder
- 16" wide expanded metal steps and 10" deep top step standard, optional treads available
- Standard finish is deep gray enamel paint
- Built to OSHA and ANSI standards
- 30" handrails



Model No.	Ht. (in) Top Step	Ht. (in) Overall	No. of Steps	Base Width (in)	Base Depth (in)	Wt. (lbs)
FAWL-5	47.5	77.5	5	30	42	70
FAWL-6	57	87	6	30	48	80
FAWL-7	66.5	96.5	7	30	54	90
FAWL-8	76	106	8	30	60	100
FAWL-9	85.5	115.5	9	30	66	115
FAWL-10	95	125	10	30	72	125
FAWL-11	104.5	134.5	11	30	78	140
FAWL-12	114	144	12	30	84	150

Tilt and Roll Ladders

- Balanced design allows ladder to tilt easily and roll effortlessly on two 4" casters
 - Oversized 20" deep by 24" wide top step
 - 24" wide X-tread steps standard, optional treads available
 - 300 lbs. load rating
 - Standard finish is deep gray enamel paint
 - Complies with OSHA and ANSI standards
- Two available styles:
- Non-straddle Base (Option: Removable 10" x 24" tool tray)
 - Double Straddle Base (comes Std. with a 10" x 24" tool tray)



Model No.	Ht. (in) Top Step	Ht. (in) Overall	No. of Steps	Base Width (in)	Base Depth (in)	Wt. (lbs)
Non-Straddle Base						
TR-3	28.5	58.5	3	30	40	60
TR-4	38	68	4	30	46	72
TR-5	47.5	77.5	5	30	52	84
TR-6	57	87	6	30	58	96
Double Straddle Base						
HL-3	28.5	58.5	3	26	38	77
HL-4	38	68	4	26	44	89
HL-5	47.5	77.5	5	26	50	101
HL-6	57	87	6	26	56	113

Ballymore/Garlin Ladders

Dock & Mezzanine Ladders

• One piece welded construction provides safe access to docks and mezzanines Available in two styles:

- 1) Walk-Thru - Handrails extend 42" above top rung
- 2) Side-Step - Have four additional hand-hold rungs.

Model should be mounted with exit rung matching dock height

- Constructed of 1" schedule 40 pipe with 3/4" diameter non-slip rungs
- Rungs are 18" wide, spaced on 12" centers
- Pre-drilled fastener plates (fasteners not included)
- Wall stand-off is 10"
- Standard finish is deep gray enamel paint
- Built to OSHA codes

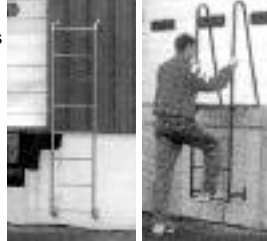

Options:

Snap chain at top of walk-thru ladders add suffix C
Straight legs at bottom, specify walk-off height
Safety Orange finish

Model No.	Climbing Rungs	Total Rungs	Wt. (lbs)
Side-Step, 2-10			
MD2SS	2	6	38
MD3SS	3	7	44
MD4SS	4	8	50
MD5SS	5	9	56
MD6SS	6	10	62
MD7SS	7	11	68
MD8SS	8	12	74
MD9SS	9	13	80
MD10SS	10	14	90

Model No.	No. of Rungs	Wt. (lbs)
Walk-Thru, 2-10		
MD2WT	2	53
MD3WT	3	59
MD4WT	4	65
MD5WT	5	71
MD6WT	6	77
MD7WT	7	83
MD8WT	8	89
MD9WT	9	95
MD10WT	10	101

Pivot-In-Place Ladders

- Center casters allow ladder to pivot around its own radius
- Comes standard with R-tread, optional treads available
- Standard finish is deep gray enamel paint
- 300 lbs. load capacity
- Easy operating lockstep with foot pedal
- Built to OSHA and ANSI standards
- CAL OSHA available
- 30" handrails

Model No.	Ht. (in)		No. of Steps	Base Width (in)	Base Depth (in)	Wt. (lbs)
	Top Step	Overall				
PIP-6-R	57	87	6	24	43	70
PIP-7-R	66.5	96.5	7	24	49	82
PIP-8-R	76	106	8	24	55	94
PIP-9-R	85.5	115.5	9	30	61	150
PIP-10-R	95	125	10	30	67	170
PIP-11-R	104.5	134.5	11	30	73	182
PIP-12-R	114	144	12	30	79	192

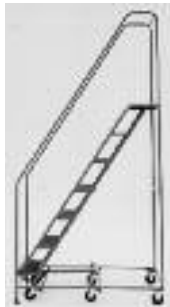

Bally/Lifts

For one worker at working height to 21'

Hydraulic systems have dual action hand pump. Optional 120V AC and 12V DC drives available.

Enclosed deck has 42" high guardrails, midrails, gate and toeboards. Base equipped with four leveling jacks, 6" casters.

Fully-lowered, Bally/Lifts fit through standard-size door openings. Rated at 300-lb. capacity.

Bally/Lifts available with 64" long deck with 34" cantilever. Rated at 300-lb. capacity.

Model No.	Wkg. Ht. (ft)	Platform Ht (ft/in)		Platform Size (in)		Wt. (lbs)
		Max.	Min.	L	W	
BL-315*	21'	15'	6'4"	20	28	590
Cantilevered Platform						
BL-C14**	20'	14'	6'4"	64	21	900

* Base is 65" long by 32" wide. With outriggers extended, each unit's base is 65" x 68"

** Cantilevered aluminum platform extends 34" beyond base.



MRO Maintenance Lifts

For two workers at working heights to 34'

Four standard models. Available with AC or DC electric- hydraulic drive: 120V motor with thermal overload and 25' power cord; 12V DC system with two long-life batteries and trickle-type charger.

Large 36" x 28" decks hold two workers, have 42" high guardrails, midrails and toeboards. Base equipped with four adjustable jacks, 8" casters.

With telescoping sections lowered and rails folded, MROs pass through 7-ft high doorways. Rated at 500-lb. capacity.



Model No.	Working Ht. (ft)	Platform Ht. (ft/in)		Wt. (lbs)
		Max.	Min.†	
MR-15-AC	21	15'	6'4"	800
MR-15-DC				930
MR-20-AC	25	19'3"	6'4"	1000
MR-20-DC				1130
MR-24-AC	30	23'8"	6'7"	1200
MR-24-DC				1330
MR-28-AC	34	28'	6'10"	1420
MR-28-DC				1550

† To determine vertical storage height, add 2" to minimum platform height.

Note: All platform-deck dimensions are 36" x 28". All base dimensions are 2'8" x 6'3" without jacks. (With jacks in storage position, dimensions are 2'9" x 6'11". With jacks extended, base dimensions are 6'4" x 6'3").

Ground Entry Order Picker

- Rated capacity: 300 lbs./one person.
- Totally enclosed 26" x 28" platform with 42" guardrails, midrails and gate; 4" toeboards and skid-resistant deck.
- Welded compact base frame with 6" casters (2 are locking swivel casters) for easy rolling and maneuverability.
- Standard finish is chip-resistant gray enamel paint.
- 12 Volt DC power (for raising and lowering) includes battery and charger; 80 to 100 raise and lower cycles between charges on a normal 8-hour shift.
- Raised deck heights: Ground Entry - 9'6" ; One Step Entry - 10' 6".
- Built-in storage shelves:
Ground Entry Model: OP-10; Two 24" x 24" shelves; One Step Entry Model: OP-11; Two 18" x 24" shelves.
- One Step Entry unit includes a 20" x 28" shelf that raises and lowers with the platform.
- Compact design for doorway passage and easy storage.



Base Size 32" x 63"

Model No.	Wkg. Ht. (ft)	Platform Ht. (ft/in)		Overall Ht. (deck fully Lowered)	Platform Size (in)		Wt. (lbs)
		Min. (in)	Max. (ft/in)		L	W	
Ground Entry							
OP-10	15	12	9'6"	6'4"	26	28	590
One Step Entry							
OP-11	16	23"	10'6"	6'6"	26	28	600

Hydraulic-Powered Elevating Platforms

These high-performance, low maintenance work platforms are equipped with hydraulic systems and are available with AC, DC or air-motor drives. The standard drive is a fully grounded 120V electric motor and 25' of 3-wire cable with grounded plug.

Every platform is all-welded, unitized construction, with four 8" swivel casters with combined wheel and swivel locks, built-in access to lowered platform, and 1000-lb. Lifting/holding capacity. Large 3' x 8' platform with serrated grating deck. Cantilever platform optional.

Model No.	Wkg. Ht. (ft)	Platform Ht. (ft/in)		Stabilizers	Wt. (lbs)
		Max.	Min.		
HW1-7	13	7'4"	2'4"		1700
HW1-10	16	10'1"	5'	Not Required	1800
HW2-13	19	12'10"	3'		2000
HW2-16*	21	15'8"	5'8"		2100
HW3-19*	24	18'8"	3'7"	Standard Equipment	2300
HW3-22**	27	21'4"	6'4"		2400
HW4-24**	30	24'4"	4'1"		2700
HW4-27**	33	27'	6'8"		2800

NOTE: All base dimensions are 9 by 4 ft.

* Add 20" to 4-ft base width for extended stabilizers.

** Add 40" to 4-ft base width for extended stabilizers.



Ladders

Ballymore/Garlin Ladders

Tank-Top Lift

Access to tank truck and railroad car hatches or other applications requiring cantilevered work decks, is easy with Ballymore's all-welded rugged steel Tank-Top lifts. Flat steps provide access to the 9' high landing; a telescoping ladder with slip-resistant rungs provides access to the 4' long by 2' wide cantilevered deck at raised heights. Deck height is hydraulically adjustable from 9' to 13' under clearance.



Model No.	Deck Height Above Fork	Cap. (lbs)	Wt. (lbs)
TT9-13	Adjustable 9' to 13'	300	1525
TT9-13F	Non-adjustable 9' to 13'	300	1450

*Specify selected height. Factory will preset height to bottom of deck. Base ls 28" x 60". Outrigger Spread is 69".

Forklift Personnel Platforms

Two models guarded by screen and 42" guardrails, covered with non-slip mat. Rated at 500-lb. capacity. Two 2" x 7" fork pockets on 30" centers. Four 4" casters, two rigid, two swivel. Options available.



Model No.	Deck (in)	Overall Ht. Above Fork (in)	Wt. (lbs)
FD-0-C	36 x 36	60	130
FD48C	48 x 36	60	180

NOTE: User safety requires adequately rated forklift truck and secure attachment of work platform to truck.

Mobile Work Platforms, 3 to 5 steps

These all-welded platforms are available in 24" and 36" widths. Expanded metal decks on 24" wide models; Serrated grating decks on 36" wide models. Units have 300-lb. rated capacity, with 4:1 safety factor. Each platform has two 4" rigid casters at rear and stair rails. The two 5-step models are equipped with 30" high deck rails. Options include two 4" swivel casters, 30" deck rails on 3- and 4-step models.



No. of Steps	Platform Ht. (in)	Length (in)		24" wide		36" wide	
		Deck	Overall	Model No.	Wt. (lbs)	Model No.	Wt. (lbs)
3	28-1/2	36	48	B32-3	63	B33-3	103
		48	60	B32-4	85	B33-4	125
		60	72	B32-5	95	B33-5	140
4	38	36	54	B42-3	85	B43-3	131
		48	66	B42-4	107	B43-4	159
		60	78	B42-5	117	B43-5	174
5	47-1/2	36	60	B52-3	111	B53-3	165
		48	72	B52-4	125	B53-4	181
		60	84	B52-5	137	B53-5	198

Portable Crossovers with Stairway Slope

- One-piece all-welded steel construction.
- Steps have stairway slope (48°): Gradual incline allows worker to face outward when descending.
- Frame & Rails: 1" O.D. high strength tubing.
- Steps & Bridge Tread: Solid steel with anti-skid mats (prevents foot debris from falling through tread onto product).
- Steps and platform (all models) - 24" wide (26" overall width).
- Rails on both sides of steps and platform - 30" high.
- Rubber Tips on legs keep crossover in place.
- Finish: Corrosion resistant gray enamel tread.
- 300 lbs. rated capacity.
- Optional Tread: Open serrated grating.



Model No.	No. of Steps Including Platform	Platform Ht. (in)	Min. Vert. Clearance (in)	Min. Horiz. Clearance (in)	Base Length (in)	Ship. Wt. (lbs)
PC3-24	3	30	26	10	60	110
PC3-36	3	30	26	22	72	126
PC3-48	3	30	26	34	84	148
PC4-24	4	40	36	10	78	134
PC4-36	4	40	36	22	90	156
PC4-48	4	40	36	34	102	174
PC5-24	5	50	46	10	96	159
PC5-36	5	50	46	22	108	181
PC5-48	5	50	46	34	120	198

Single-Access Double-Access Mobile Work Platforms, 3 to 7 Steps

All platforms feature welded construction, with full-width steps, 600-lb. capacity & 4:1 safety factors. Overall width 30" Platforms equipped w/four 5" casters, 28" wide serrated grating decks, 36" high 1" dia. steel pipe top rails & midrails. Single-Entry platforms have full rails; 3 & 4-step Double-Entry models have deck rails one side, 5, 6 and 7-step models have deck rails both sides (work side is removable).



Option: removable rails on second side of 3 and 4-step DE units.

No. of Steps	Platform Ht. (in)	Platform Dim (in)		Double-Entry			Single-Entry		
		L	W	Overall Length (in)	Model No.*	Wt. (lbs)	Overall Length (in)	Model No.**	Wt. (lbs)
3	30	36	28	60	DE3-3	161	48	SE3-3	150
				72	DE3-4	179	60	SE3-4	170
				84	DE3-5	198	72	SE3-5	196
				96	DE3-6	215	84	SE3-6	215
4	40	36	28	72	DE4-3	194	54	SE4-3	173
				84	DE4-4	211	66	SE4-4	193
				96	DE4-5	230	78	SE4-5	219
				108	DE4-6	246	90	SE4-6	237
5	50	36	28	84	DE5-3	224	60	SE5-3	191
				96	DE5-4	242	72	SE5-4	213
				108	DE5-5	260	84	SE5-5	237
				120	DE5-6	279	96	SE5-6	257
6	60	36	28	96	DE6-3	266†	66	SE6-3	217
				108	DE6-4	283†	78	SE6-4	235
				120	DE6-5	302†	90	SE6-5	259
				132	DE6-6	318†	102	SE6-6	284†
7	70	36	28	108	DE7-3	296†	72	SE7-3	224
				120	DE7-4	315†	84	SE7-4	264
				132	DE7-5	334†	96	SE7-5	285†
				144	DE7-6	350†	108	SE7-6	305†

* Each platform has four 5" swivel casters with combination wheel and swivel locks.
** Each platform has two 5" swivel casters with combination wheel and swivel locks, two 5" rigid casters.
† Rails removed for shipping. Full rails recommended for double-access models.

Fixed Crossovers

These welded-steel industrial crossovers help provide maximum use of floor space. Separate bridge and stair sections are supplied with top and midrails, and a choice of deck and tread materials either non-skid or self-cleaning open material. Any combination of six heights, five lengths and three widths can be selected. Rated at 500-lb. capacity, crossovers have a 4:1 safety factor.



Stair Sections (Set of 2) for Industrial Crossovers
2 to 7 steps... with choice of widths

No. of Steps Each Section	Vertical Clearance (in)	27" Overall Width (Expanded Metal)		31-1/2" Overall Width (Serrated Grating)		38-1/2" Overall Width (Serrated Grating)	
		Model	Wt. (lbs)	Model	Wt. (lbs)	Model	Wt. (lbs)
2	28	CS227	253	CS231	254	CS238	276
3 last	38	CS327	310	CS331	310	CS338	351
4 step	48	CS427	378	CS431	393	CS438	428
5 is	58	CS527	445	CS531	465	CS538	505
6 onto	68	CS627	517	CS631	537	CS638	583
7 bridge	78	CS727	600	CS731	630	CS738	680

Step rise 10"; run 9" per step.

Bridge Sections for Industrial Crossovers

Combine any length with appropriate width stair sections.

No. of Steps Each Section	Horz. Clearance (in)	27" Overall Width (Expanded Metal)		31-1/2" Overall Width (Serrated Grating)		38-1/2" Overall Width (Serrated Grating)	
		Model	Wt. (lbs)	Model	Wt. (lbs)	Model	Wt. (lbs)
20	18	-CB227	88	-CB231	95	-CB238	102
30	28	-CB327	111	-CB331	120	-CB338	128
40	38	-CB427	133	-CB431	140	-CB438	153
50	48	-CB527	156	-CB531	165	-CB538	180
60	58	-CB627	195	-CB631	203	-CB638	220

Green Bull Ladders

FIBERGLASS:

Series 2032 Fiberglass Step Ladder

Type IA Extra Heavy Duty 300 Lb. Duty Rating

- **Armor Plated Legs** - Fiberglass sleeves surround the lower legs protecting the area from damage and wear.
- **Gusseted Back Braces** - All back braces are fully gusseted for extra rigidity.
- **Heavy Duty Step Attachment** - Each step is attached by 6 steel rivets.
- **Molded Top with Recessed Tool Tray** - non-conductive material resists denting or bending. Includes tool holes and a built-in paint can hook.
- **Steel Reinforced Spreader Connection** - Located inside the rails for protection during transit and storage. Extra steel plates strengthen the hinge area on the outside of the rail.



Cat. No.	Size (ft)	Step Size (in)	Bottom Width (in)	Approx. Spread (in)	Approx. Wt. (lbs)
203203	3	3	18	22-3/8	15
203204	4	3	19-1/2	28-3/8	18
203205	5	3	21	34-3/8	22
203206	6	3	22-1/2	40-1/4	25
203207	7	3	24	46-1/4	31
203208	8	3	25-1/2	52-1/4	35
203210	10	3	28-1/2	64-1/4	44
203212	12	3	31-1/2	76-1/4	54

Series 2022 Fiberglass Step Ladder

Type IA Extra Heavy Duty 300 Lb. Duty Rating

- **Inside Spreader Braces** - Located inside the rails for protection during transit and storage.
- **Reinforced Back Braces** - Formed back braces are stronger than standard angle stock, without adding weight.
- **Double Gusseted Bottom Step** - Two heavy formed steel gussets on each side provide greater strength than flat braces.
- **Molded Top With Recessed Tool Tray** - Non-conductive material resists denting or bending. Includes tool holes and a built-in paint can hook.
- **Molded Wrap Around Boot** - Structural PVC boot supports the lower leg for durability and abrasion resistance.
- **Heavy Duty Step Attachment** - Each step is attached by six steel rivets.



Cat. No.	Size (ft)	Step Size (in)	Bottom Width (in)	Approx. Spread (in)	Approx. Wt. (lbs)
202204	4	3	19-1/4	28-3/8	17
202205	5	3	20-3/4	34-3/8	21
202206	6	3	22-1/4	40-1/4	23
202208	8	3	25-1/4	52-1/4	32
202210	10	3	28-1/4	64-1/4	41
202212	12	3	31-1/4	76-1/4	51

Series 2113 Aluminum-Top Fiberglass Step Ladder

Type IA Extra Heavy Duty 300 Lb. Duty Rating

- **Extruded Aluminum-Top** - Heavy-gauge aluminum with tool tray and tool holes. Attached with steel rivets and aluminum backup plates.
- **Inside Spreader Braces** - Located inside the rails for protection during transit and storage.
- **Heavy Duty Step Attachment** - Each step is attached by 6 steel rivets.
- **Armor Plated Legs** - Fiberglass sleeves surround the lower legs, protecting the area from damage and wear.



- continues -

Series 2113 Aluminum-Top Fiberglass Step Ladder (continued)

Cat. No.	Size (ft)	Bottom Width (in)	Approx. Spread (in)	Approx. Wt. (lbs)
211303	3	18	22-3/8	16
211304	4	19-1/2	28-3/8	19
211305	5	21	34-3/8	23
211306	6	22-1/2	40-1/4	26
211307	7	24	46-1/4	32
211308	8	25-1/2	52-1/4	36
211310	10	28-1/2	64-1/4	45
211312	12	31-1/2	76-1/4	55

Series 2112 Aluminum-Top Fiberglass Step Ladder

Type IA Extra Heavy Duty 300 Lb. Duty Rating

- **Extruded Aluminum-Top** - Heavy gauge aluminum with tool tray and tool holes. Attached with steel rivets and aluminum backup plates.
- **Inside Spreader Braces** - Located inside the rails for protection during transit and storage.
- **Heavy Duty Step Attachment** - Each step attachment is attached by 6 steel rivets.
- **Slip Resistant Shoes** - Sturdy aluminum shoes have serrated treads for excellent traction on many surfaces.



Cat. No.	Size (ft)	Bottom Width (in)	Approx. Spread (in)	Approx. Wt. (lbs)
211104	4	19-1/4	28-3/8	17
211105	5	20-3/4	34-3/8	21
211106	6	22-1/4	40-1/4	23
211108	8	25-1/4	52-1/4	32
211210	10	28-1/4	64-1/4	41
211212	12	31-1/4	76-1/4	51

Series 2042 Fiberglass Double Entry Step Ladder

Type IA Extra Heavy Duty 300 Lb. Duty Rating

- **Double Gusseted Bottom Step** - Two heavy formed steel gussets on each side provide greater strength than flat braces.
- **Heavy Duty Top Hinge** - All steel top hinge uses 10 steel rivets on each side for long-lasting strength and durability.
- **Heavy Duty Step Attachment** - Each step is attached by 6 steel rivets.
- **Steel Reinforced Spreader Connection** - Located inside the rails for protection during transit and storage. Extra steel plates strengthen the hinge area on the outside of the rail.
- **Armor Plated Legs** - Fiberglass sleeve surrounds the lower legs, protecting the area from damage and wear.



* Ladder can be used by two people at the same time, not to exceed 300 lbs. per side.

Cat. No.	Size (ft)	Step Size (in)	Bottom Width (in)	Approx. Spread (in)	Approx. Wt. (lbs)
204203	3	3	18	30-5/8	22
204204	4	3	19-1/2	38-1/2	26
204205	5	3	21	45-1/2	30
204206	6	3	22-1/2	53	36
204207	7	3	24	60-1/2	40
204208	8	3	25-1/2	68	44
204210	10	3	28-1/2	83	61
204212	12	3	31-1/2	98	74
204214	14	3	34-1/2	112-7/8	91
204216	16	3	37-1/2	127-7/8	103

Ladders

Green Bull Ladders

Series 2062 Fiberglass Double Entry Step Ladder

Type IA Extra Heavy Duty 300 Lb. Duty Rating

- **Heavy Duty Top Hinge** - All steel top hinge uses 10 steel rivets on each side for long-lasting strength and durability.
- **Inside Spreader Braces** - Located inside the rails for protection during transit and storage.
- **Molded Wrap Around Boot** - Structural PVC boot supports the lower leg for durability and abrasion resistance.
- **Heavy Duty Step Attachment** - Each step is attached by 6 steel rivets.

* Ladder can be used by two people at the same time, not to exceed 300 lbs. per side



Cat. No.	Size (ft)	Step Size (in)	Bottom Width (in)	Approx. Spread (in)	Approx. Wt. (lbs)
206204	4	3	19-1/4	38-1/8	25
206205	5	3	20-3/4	45-1/2	28
206206	6	3	22-1/4	53	33
206208	8	3	25-1/4	68	42
206210	10	3	28-1/4	83	57
206212	12	3	31-1/4	98	69

Series 5700 Fiberglass Tripod Ladder

SPECIAL PURPOSE 300 Lb. Duty Rating

- **Bail-Type Spreader Handle** - Allows one hand operation for folding or setting up quickly.
- **Triple Gusseted Bottom Step** - 3 heavy steel gussets on each side provide extra stability and strength.
- **Fully Gusseted Steps** - Steps feature 2 heavy steel gussets, for greater strength. Each step is attached by 6 steel rivets.
- **Heavy Duty Top Hinge** - Steel straps connect the pivot points to the main ladder rails, enhancing the strength of the hinge.



Cat. No.	Size (ft)	Step Size (in)	Approx. Spread (in)	Approx. Wt. (lbs)
5704	4	3	30-3/4	17
5705	5	3	37-1/4	20
5706	6	3	43-3/4	23
5707	7	3	50-1/4	27
5708	8	3	57	31
5710	10	3	70-3/4	42
5712	12	3	77-1/2	51

Series 2052 Fiberglass Platform Ladder

Type IA Extra Heavy Duty 300 Lb. Duty Rating

- **Large Stable Platform** - Slip-resistant serrated surface is a full 21" x 13-1/2". The platform locks the ladder in place when in the open position.
- **Heavy Duty Step Attachment** - Each step is attached by 6 steel rivets.
- **Armor Plated Legs** - Fiberglass sleeve surrounds the lower legs, protecting the area from damage and wear.
- **Gusseted Back Braces** - All back braces are fully gusseted for extra rigidity.
- **Top Rail Guard** - Aluminum cross brace creates a convenient railing for working from the platform



Cat. No.	Size* (ft)	Step Size (in)	Bottom Width (in)	Approx. Spread (in)	Approx. Wt. (lbs)
205202	2	3	22-1/2	32-3/8	21
205203	3	3	24	38-3/8	25
205204	4	3	25-1/2	44-3/8	30
205205	5	3	27	50-3/8	32
205206	6	3	28-1/2	56-3/8	38
205207	7	3	30	62-1/4	43
205208	8	3	21-1/2	68-1/4	49
205210	10	3	34-1/2	80-1/8	60
205212	12	3	37-1/2	92	71

* Size is equal to distance from floor to top of platform

Series 5200W Fiberglass Workstand

Type IA Extra Heavy Duty 300 Lb. Duty Rating

- **Pinch-Free Spreader Braces** - Double-rivet center hinge protects user from pinched fingers.
- **Extra Wide Work Surface** - Slip restraint serrated surface is 27-1/2" wide (9" Deep).
- **Fully Gusseted Steps** - Steps feature 4 heavy steel gussets for greater strength. Each step is attached by 6 steel rivets.
- **Heavy Duty Hinge** - Plated steel hinge is designed to resist corrosion and deliver years of trouble-free performance.



Cat. No.	Size (ft)	Step Size (in)	Bottom Width (in)	Approx. Spread (in)	Approx. Wt. (in)
5200W-2	2	3	30-1/2	22-3/8	14
5200W-3	3	3	32	29-7/8	18

Series 2012 Fiberglass Shelf Ladder

Type IA Extra heavy Duty 300 Lb. Duty Rating

- **Armor Plated Legs** - Fiberglass sleeve surrounds the lower legs, protecting the area from damage and wear.
- **Double Gusseted Bottom Step** - Two heavy formed steel gussets on each side provide greater strength than flat braces
- **Heavy Duty step Attachment** - Each step is attached by 6 steel rivets.
- **Rubber Shelf Bumpers** - Upper rails and top step are faced with durable rubber to protect shelves and reduce slipping. Attachment rivets are recessed to prevent marring.



Cat. No.	Size (ft)	Step Size (in)	Bottom Width (in)	Approx. Wt. (lbs)
201203	3	3	18	10
201204	4	3	18	12
201205	5	3	18	14
201206	6	3	18	16
201207	7	3	18	18
201208	8	3	18	21
201210	10	3	18	25
201212	12	3	18	28

Series 6062 Fiberglass Extension Ladder

Type IA Extra Heavy Duty 300 Lb. Duty Rating

- **Cast Aluminum Rung Lock** - Spring-assisted mechanism has polycarbonate flippers for longer life and a quiet sliding action over the rungs.
- **Direct Rung Connection** - Serrated slip-resistant rungs are hydraulically crimped directly to the side rails for a strong and rigid connection.
- **Full-Length Interlocking Rails** - Provide smooth sliding action and an extra margin of security.
- **Outside Slide Guides** - Two heavy duty slide guides are secured to the top of the base section with 4 rivets per guide for added strength.
- **Heavy Duty Steel Shoe Assembly** - Thick rubber treads and convenient flip-down spikes provide a solid foundation.



Cat. No.	Size (ft)	Step Size (In)	Approx. Wt. (lbs)
606216	16	1-5/8	37
606220	20	1-5/8	45
606224	24	1-5/8	52
606228	28	1-5/8	59
606232	32	1-5/8	70
606236*	36	1-5/8	79
606240*	40	1-5/8	86

Available as single section: Series 6052
*Type 1,250 lb. Duty Rating

Green Bull Ladders

Series 6022 Fiberglass Extension Ladder

Type I Heavy Duty 250 Lb. Duty rating

- **Cast Aluminum Rung Lock** - Spring-assisted mechanism has polycarbonate flippers for longer life and a quiet sliding action over the rungs.
- **Direct Rung Connection** - Serrated slip-resistant rungs are hydraulically crimped directly to the side rails for a strong and rigid connection.
- **Full-Length Interlocking Rails** - Provide smooth sliding action and an extra margin of security.
- **Outside Slide Guides** - Two heavy duty slide guides are secured to the top of the base section with 4 rivets per guide for added strength.
- **Heavy Duty Steel Shoe Assembly** - Thick rubber treads and convenient flip-down spikes provide a solid foundation.



Outside Width:	Base: 17-1/8"	Fly: 15-3/8"	
Inside Width:	Base: 14-3/4"	Fly: 13"	
Cat. No.	Size (ft)	Step Size (in)	Approx. Wt. (lbs)
602216	16	1-5/8	35
602220	20	1-5/8	43
602224	24	1-5/8	50
602228	28	1-5/8	57

Series 6032 Fiberglass Manhole Ladder

Special Purpose 300 Lb. Duty Rating

- **Structural PVC Wear Sleeves** - Protects the rails from sharp edges and abrasive surfaces. Sleeve surrounds the front, side, and back of each rail.
- **Wide Utility-Style Safety Shoe** - Rounded "hoop" profile provides solid footing. Covered with a slip-resistant rubber tread.
- **Riveted Rung Plates** - Each rung is secured to the rail with a sturdy aluminum plate and 4 rivets on each side of the section.
- **12" Maximum outside dimension** - Narrow width is standard for access to manholes



Outside Width:	11-5/8"			
Inside Width:	9-1/4"			
Cat. No.	Size (ft)	Ring Size (in)	Bottom Width (in)	Approx. Wt. (lbs)
603208	8	1-1/4	12	16
603210	10	1-1/4	12	20
603212	12	1-1/4	12	23
603214	14	1-1/4	12	26
603216	16	1-1/4	12	31
603218	18	1-1/4	12	35
603220	20	1-1/4	12	39

ALUMINUM:

Jaws Combination Ladder

Type IA Extra Heavy Duty 300 Lb. Duty Rating

- **Spring-Loaded Extension Lock** - Pulls out for adjustment and snaps in place to lock.
- **Toothed Hinge Lock** - Large interlocking teeth create a positive locking system. Simple visual confirmation that ladder is in locked position.
- **Trapezoid Step** - Double angle shape presents a flat non-slip surface for use as a step ladder or straight ladder.

This Combination Ladder Can Be Used As:

- Extension Ladder • Flush Step Ladder
- Large Step Ladder • Inside Straight Ladder
- Small Step Ladder • Scaffold
- Staircase Ladder



Jaws Combination Ladder TELESCOPIC CLIMBING SYSTEMS							
Type Ia Extra Heavy Duty 300 Lb. Duty Rating - Aluminum Only							
Cat. No.	Folded Height (ft.in)	Step Size (in)	Extension Range (ft)	Step Ladder Range (ft.in)	Scaffold Height (ft)	Bottom Width (in)	Approx. Wt. (lbs)
JLT-18	4'9"	1-1/4	9-15	4'6"-7'6"	Up to 4'	26-3/8	36
JLT-22	5'9"	1-1/4	11-19	5'6"-9'6"	Up to 5'	26-3/8	41
JLT-26	6'9"	1-1/4	13-23	6'6"-11'6"	Up to 6'	26-3/8	50
Type I Heavy Duty 250 Lb. Duty Rating - Aluminum Only							
JJT-14	3'5"	1-1/4 x 2-1/2	6'3" - 10'6"	3'2" - 5'3"	Up to 3'	19-3/8	21
JJT-17	4'5"	1-1/4 x 2-1/2	7'3" - 14'6"	4'2" - 7'	Up to 4'	22-7/8	26

- continues -

Jaws Combination Ladder (continued)

Jaws* Combination Ladder NON-TELESCOPIC CLIMBING SYSTEM						
Type I Heavy Duty 250 Lb. Duty Rating - Aluminum						
Cat. No.	Folded Height (ft.in)	Step Size (in)	Straight Ladder Height (ft.in)	Step Ladder Range (ft)	Bottom Width (in)	Approx. Wt. (lbs)
JJL-9	4'3"	2-1/4	8'6"	4	19	14
JJL-11	5'3"	2-1/4	10'6"	5	20-1/2	17
JJL-13	6'3"	2-1/4	12'6"	6	22	20
Type I Heavy Duty 250 Lb. Duty Rating - Fiberglass						
JJL-9	4'3"	2-1/4	8'6"	4	20	18
JJL-11	5'3"	2-1/4	10'6"	5	21-1/4	22
JJL-13	6'3"	2-1/4	12'6"	6	22-1/2	26

*Special discounts apply to Jaws products; call for more details

Series 2061 Aluminum Step Ladder

Type IA Extra Heavy Duty 300 Lb. Duty Rating

- **Double Rivet Spreader Connection** - Spreader attaches to rail with two aluminum rivets for extra strength in this key stress area.
- **Double Gusseted Bottom Step** - Two heavy formed steel gussets on each side provide greater strength than flat braces.
- **Molded Top With Recessed Tool Tray** - Non-conductive material resists denting or bending. Includes tool holes and a built-in paint can hook.
- **Heavy Duty Step Attachment** - Each step is attached by 6 rivets.
- **Inside Spreader Braces** - Located inside the rails for protection during transit and storage.



Cat. No.	Size (ft)	Step Size (in)	Bottom Width (in)	Approx. Spread (in)	Approx. Wt. (lbs)
206103	3	3	17-3/4	22-3/8	11
206104	4	3	19-1/4	28-3/8	12
206105	5	3	20-3/4	34-3/8	15
206106	6	3	22-1/4	40-1/4	19
206107	7	3	23-3/4	46-1/4	23
206108	8	3	25-1/4	52-1/4	27
206110	10	3	28-1/4	64-1/4	32
206112	12	3	31-1/4	76-1/4	40
206114	14	3-9/16	34-1/4	89-1/4	59
206116	16	3-9/16	37-1/4	101-1/8	70
206118	18	3-9/16	40-1/4	113	79
206120	20	3-9/16	43-1/4	124-7/8	88

Series 2041 Aluminum Double Entry Step Ladder

Type IA Extra Heavy Duty 300 Lb. Duty Rating

- **Inside Spreader Braces** - Located inside the rails for protection during transit and storage.
- **Heavy Duty Top Hinge** - All steel top hinge attached by 10 aluminum rivets on each side for long lasting strength and durability
- **Heavy Duty Step Attachment** - Each step is attached by 6 aluminum rivets.
- **Slip-Resistant Shoes** - Sturdy aluminum shoes have serrated rubber treads for excellent traction on many surfaces.
- **Double Riveted Spreader Connection** - Spreader attaches to rail with two aluminum rivets for extra strength in this key stress area.

* Ladder can be used by two people at the same time, not to exceed 300 lbs. per side.

Cat. No.	Size (ft)	Step Size (in)	Bottom Width (in)	Approx. Spread (in)	Approx. Wt. (lbs)
204103	3	3	17-3/4	30-5/8	17
204104	4	3	19-1/4	38-1/8	20
204105	5	3	20-3/4	45-1/2	24
204106	6	3	22-1/4	53	27
204107	7	3	23-3/4	60-1/2	30
204108	8	3	25-1/4	68	34
204110	10	3	28-1/4	83	46
204112	12	3	31-1/4	98	56
204114	14	3-9/16	34-1/4	112-7/8	98
204116	16	3-9/16	37-1/4	127-3/4	110
204118	18	3-9/16	40-1/4	142-5/8	120
204120	20	3-9/16	43-1/4	157-1/2	132

Ladders

Green Bull Ladders

Series 2081 Aluminum Step Ladder

Type I Heavy Duty 250 Lb. Duty Rating

- **Molded Top With Recessed Tool Tray** - Non-conductive material resists denting or bending. Includes tool holes and a built-in paint can hook
- **Gusseted Back Braces** - All back braces are fully gusseted for added rigidity.
- **Slip-Resistant Shoes** - Sturdy aluminum shoes have serrated rubber treads for excellent traction on many surfaces.
- **Pinch-Free Spreader Braces** - Double-rivet center hinge protects user from pinched fingers.



Cat. No.	Size (ft)	Step Size (in)	Bottom Width (in)	Approx. Spread (in)	Approx. Wt. (lbs)
208103	3	3	17-5/8	22-1/8	10
208104	4	3	19-1/8	28-1/8	11
208105	5	3	20-5/8	34-1/8	13
208106	6	3	22-1/8	40	15
208107	7	3	23-5/8	46	18
208108	8	3	25-1/8	52	21
208110	10	3	28-1/8	64	26

Series 2051 Aluminum Platform Ladder

Type IA Extra Heavy Duty 300 Lb. Duty Rating

- **Heavy Duty Step Attachment** - Each step is attached by 6 aluminum rivets.
- **Large, Stable Platform** - Slip-resistant serrated surface is a full 21" x 13-1/2". The platform locks the ladder when in the open position.
- **Top Rail Guard** - Aluminum cross brace creates a convenient railing for working from the platform.
- **Slip-Resistant Shoes** - Sturdy aluminum shoes have serrated rubber treads for excellent traction on many surfaces.



Cat. No.	Size* (ft)	Step Size (in)	Bottom Width (in)	Approx. Spread (in)	Approx. Wt. (in)
205102	2	3	22-1/4	32-3/8	15
205103	3	3	23-3/4	38-3/8	20
205104	4	3	25-1/4	44-3/8	24
205105	5	3	26-3/4	50-3/8	27
205106	6	3	28-1/4	56-3/8	29
205107	7	3	29-3/4	62-1/4	32
205108	8	3	31-1/4	68-1/4	35
205110	10	3	34-1/4	80-1/8	41
205112	12	3-9/16	37-1/4	92	57
205114	14	3-9/16	40-1/4	103-7/8	76

*Size is equal to distance from floor to top of platform

Series 750W Aluminum Workstand

Type IA Extra Heavy Duty 300 Lb. Duty Rating

- **Pinch-Free Spreader Braces** - Double-rivet center hinge protects user from pinched fingers.
- **Fully Gusseted Steps** - Steps feature 4 heavy steel gussets for greater strength. Each step is attached by 6 aluminum rivets.
- **Heavy Duty Hinge** - Plated steel hinge is designed to resist corrosion and deliver years of trouble-free performance.
- **Extra Wide Work Surface** - Slip-resistant serrated surface is a comfortable 27-1/2" wide (9" deep).



Cat. No.	Size (ft)	Step Size (in)	Bottom Width (in)	Approx. Spread (in)	Approx. Wt. (in)
750W-2	2	3-5/16	30-1/2	22-3/8	14
750W-3	3	3-5/16	32	29-7/8	17

Series 2011 Aluminum Shelf Ladder

Type IA Extra Heavy Duty 300 Lb. Duty Rating

- **Heavy Duty Step Attachment** - Each step is attached by 6 aluminum rivets.
- **Double Gusseted Bottom Step** - Two heavy formed steel gussets on each side provide greater strength than flat braces.
- **Rubber Shelf Bumpers** - Upper rails and top step are faced with durable rubber to protect shelves and reduce slipping. Attachment rivets are recessed to prevent marring.



Cat. No.	Size (in)	Step Size (in)	Bottom Width (in)	Approx. Wt. (lbs)
201103	3	3	17-3/4	7
201104	4	3	17-3/4	9
201105	5	3	17-3/4	10
201106	6	3	17-3/4	13
201107	7	3	17-3/4	14
201108	8	3	17-3/4	15
201110	10	3	17-3/4	17
201112	12	3	17-3/4	20
201114	14	3-9/16	17-3/4	28
201116	16	3-9/16	17-3/4	30
201118	18	3-9/16	17-3/4	33
201120	20	3-9/16	17-3/4	38

Series 6141 Aluminum Extension Ladder

Type IA Extra Heavy Duty 300 Lb. Duty Rating

- **Outside Slide Guides** - Two sets of heavy duty slide guides are secured to the top of the base section with 4 rivets per guide for added strength.
- **Heavy Duty Pulley and Rope** - Designed to pull easily without binding or chafing. Poly rope is highly resistant to rotting and fraying.
- **Heavy Cast Aluminum Shoe Assembly** - Thick rubber threads and convenient flip-down spikes provide a strong foundation.
- **Cast Aluminum Rung Lock** - Spring-assisted locking mechanism has polycarbonate flippers for longer life and quiet sliding action over the rungs.
- **Cast Aluminum End Caps** - Provide the highest level of protection and durability for this critically high impact area.



D-Rung		Round Rung	Size (ft)	Rung Size (in)	Approx. Wt. (lbs)
614116	612116	16	1-5/8	38	
614120	612120	20	1-5/8	45	
614124	612124	24	1-5/8	52	
614128	612128	28	1-5/8	59	
614132	612132	32	1-5/8	72	
614136	612136	36	1-5/8	81	
614140	612140	40	1-5/8	89	
"D" Rung		Round Rung			
Single Section: Series 6131		Single Section: Series 6111			

Series 6101 Aluminum Extension Ladder

Type IA Extra Heavy Duty 300 Lb. Duty Rating

- **Heavy Cast Aluminum Shoe Assembly** - Thick rubber treads and convenient flip-down spikes provide a strong foundation.
- **Heavy Duty Pulley and Rope** - Designed to pull easily without binding or chafing. Poly rope is highly resistant to rotting and fraying.
- **Cast Aluminum Rung Lock** - Spring-assisted locking mechanism has polycarbonate flippers for longer life and quiet sliding action over the rungs.
- **Full-Length Interlocking Rails** - Provides smooth sliding action and an extra margin of security.
- **Nylon End Caps** - Tough, resilient nylon end caps add tremendous protection to this high impact area without adding weight.



D-Rung		Round Rung	Size (ft)	Rung Size (in)	Approx. Wt. (lbs)
610116	603116	16	1-5/8	32	
610120	603120	20	1-5/8	37	
610124	603124	24	1-5/8	45	
610128	603128	28	1-5/8	54	
610132	603132	32	1-5/8	62	
610136*	603136	36	1-5/8	71	
610140*	603140	40	1-5/8	78	
"D" Rung		Round Rung			
Single Section: Series 6091		Single Section: Series 6071			
*Base 18-1/4"					

Green Bull Ladders

Aluminum Planks

- **Heavy Duty Rung System** - Rungs are located on 12"- centers for extra strength. Larger size boards have additional lower rungs to prevent racking and buckling.
- **Raised And "Abraded" Decking** - Assured slip-resistant surface. Slots in lower level help prevent material build up.
- **Cast Aluminum Handle-Style Endcaps** - Handles on each end protect the rail ends from damage and provide convenient grip for transporting manually.



Aluminum Plank One Man Unit

250 LB. DUTY RATING							
Length (ft)	Rail Depth (in)	12" Wide		14" Wide		20" Wide	
		Cat. No.	Wt. (lbs)	Cat. No.	Wt. (lbs)	Cat. No.	Wt. (lbs)
6	3	411206	15	411406	16	412006	18
8	3	411208	20	411408	21	412008	24
10	3	411210	25	411410	26	412010	30
12	3.5	411212	36	411412	38	412012	44
14	3.5	411214	41	411414	43	412014	50
16	3.5	411216	46	411416	49	412016	56
18	3.5	411218	51	411418	54	412018	62
20	4	411220	59	411420	63	412020	73
22	4	411222	65	411422	69	412022	80
24	4	411224	71	411424	75	412024	87

Aluminum Plank Two Man Unit

500 LB. DUTY RATING											
Lgth. (in)	Rail Depth (in)	12" Wide		14" Wide		20" Wide		24" Wide		28" Wide	
		Cat. No.	Wt. (lbs)	Cat. No.	Wt. (lbs)	Cat. No.	Wt. (lbs)	Cat. No.	Wt. (lbs)	Cat. No.	Wt. (lbs)
10	3.5	421210	30	421410	32	422010	37	422410	42	422810	47
12	3.5	421212	36	421412	38	422012	44	422412	48	422812	53
14	4.5	421214	47	421414	50	422014	58	422414	62	422814	70
16	4.5	421216	53	421416	56	422016	66	422416	72	422816	79
18	4.5	421218	59	421418	63	422018	74	422418	80	422818	88
20	5.25	421220	77	421420	81	422020	93	422420	99	422820	110
22	5.25	421222	84	421422	88	422022	101	422422	108	422822	120
24	5.25	421224	91	421424	96	422024	109	422424	114	422824	130
26	6	421226	114	421426	119	422026	134	422426	143	422826	156
28	6	421228	123	421428	129	422028	145	422428	155	422828	170
30	6	421230	132	421430	137	422030	155	422430	166	422830	180
32	6	421232	141	421432	147	422032	165	422432	177	422832	192
34	6.5					422034	217	422434	228	422834	245
36	6.5					422036	229	422436	241	422836	260
38	6.5					422038	243	422438	255	422838	274
40	6.5					422040	255	422440	268	422840	288

Aluminum Plank Three Man Unit

750 LB. DUTY RATING							
Length (ft)	Rail Depth (in)	20" Wide		24" Wide		28" Wide	
		Cat. No.	Wt. (lbs)	Cat. No.	Wt. (lbs)	Cat. No.	Wt. (lbs)
14	5.25	432014	68	432414	71	432814	80
16	5.25	432016	76	432416	80	432816	90
18	5.25	432018	84	432418	89	432818	100
20	6	432020	105	432420	111	432820	121
22	6	432022	114	432422	122	432822	133
24	6	432024	125	432424	133	432824	145
26	6.5	432026	167	432426	175	432826	188
28	6.5	432028	179	432428	188	432828	206
30	6.5	432030	219	432430	228	432830	216
32	6.5	432032	233	432432	243	432832	262
34	7	432034	247	432434	259	432834	278
36	7	432036	261	432436	273	432836	294
38	7	432038	276	432438	290	432838	311
40	7	432040	291	432440	305	432840	327

Aluminum Rail Systems

- **Rail Sockets** - All planks and stages are pre-drilled for sturdy aluminum rail sockets. Allow safety rail systems to be easily added if the job requires it.
- **Stanchion Post Assembly** - 46-1/8" aluminum post supports rails and toeboards with plated U-bolts and wing nuts.
- Optional End Rail System.



Aluminum Guardrail Safety Systems

GUARDRAIL, MIDRAIL, TOEBOARD, COMPLETE ONE SIDE		
Cat. No.	Board Lgth. (in)	Approx. Wt. (lbs)
RS06	6	21
RS08	8	24
RS10	10	28
RS12	12	36
RS14	14	40
RS16	16	43
RS18	18	47
RS20	20	48
RS22	22	51
RS24	24	55
RS26*	26	58
RS28*	28	65
RS30*	30	68
RS32*	32	71
RS34*	34	75
RS36*	36	81
RS38*	38	87
RS40*	40	89

*Rail systems for planks with 6-1/2" I-beam will require spacer brackets for sockets.

End Safety Rail Systems

GUARDRAIL, MIDRAIL, TOEBOARD, COMPLETE ONE END		
Cat. No.	Board Width (ft)	Approx. Wt. (lbs)
END12	12	1
END14	14	1
END20	20	2
END24	24	2
END28	28	2

*Note: End rail system(s) used on plank with only one siderail system will require an additional stanchion post (#290310) for each end.

WOOD:

Series 300 Wood Step Ladder

Type IA Extra Heavy Duty 300 Lb. Duty Rating

- **Wrap-Around Ear Hinge** - Creates a metal-to-metal pivot for long service life. Heavy steel wraps up and over the top for strength and protection.
- **Grooved Steps** - Deep grooves and precision milled into each step to help prevent slipping. Steel knee braces on every step provide lateral rigidity.
- **Hardwood Back Rungs** - A full 1-1/8" diameter, with formed steel angle braces riveted to top and bottom rung.
- **Steel Truss Rods** - Each step is supported by a full-width truss rod, grooved into the bottom of the step to prevent snagging or damage.



Cat. No.	Size (ft)	Step Size (in)	Bottom Width (in)	Approx. Spread (in)	Approx. Wt. (lbs)
300-04	4	3-5/16	18-3/4	31	24
300-05	5	3-5/16	20-1/4	37	30
300-06	6	3-5/16	21-3/4	43	36
300-08	8	3-5/16	24-3/4	53	48
300-10	10	3-5/16	27-3/4	64	60
300-12	12	3-5/16	30-3/4	76	72
300-14*	14	3-3/4	33-3/4	88	94
300-16*	16	3-3/4	36-3/4	100	109

Front Rail: 1" x 3-1/4" Back Rail: 1" x 2-1/2"
*Front Rail: 3-1/2" Back Rail: 2-3/4"

Ladders

Green Bull Ladders

Series 305 Wood Double Entry Step Ladder

Type IA Extra Heavy Duty 300 Lb. Duty Rating

Series 005 Wood Double Entry Step Ladder

Type I Heavy Duty 250 Lb. Duty Rating

- **Wrap-Around Ear Hinge** - Creates a metal-to-metal pivot for long service life. Heavy steel wraps up and over the top for strength and protection.
 - **Grooved Steps** - Deep grooves and precision milled into each step to help prevent slipping. Steel knee braces on every step provide lateral rigidity.
 - **Steel Truss Rods** - Each step is supported by a full-width rod, grooved into the bottom of the step to prevent snagging or damage.
 - **Pinch-Free Spreader Braces** - Double-rivet center hinge protects user from pinched fingers when folding.
- * Ladder can be used by two people at the same time. For Series 305, do not exceed 300 lbs. per side. For Series 005, do not exceed 250 lbs. per side.



305
Shown

Series 1107 Wood Tripod Ladder

Special Purpose

- **Bail-Type Spreader Handle** - Allows fast one-hand operation when folding or setting up.
- **Wrap-Around Ear Hinge** - Creates a metal-to-metal pivot point for long service life. Heavy steel wraps up and over the top for strength and protection.
- **Formed Steel Knee Braces** - Angled knee braces on bottom, middle and top step provide lateral rigidity and stability.
- **Steel Truss Rods** - Each step is supported by a full-width truss rod, grooved into the bottom of the step to prevent snagging or damage.



Cat. No.	Size (ft)	Step Size (in)	Bottom Width (in)	Approx. Spread (in)	Approx. Wt. (lbs)
1107-4	4	3-5/16	26-3/4	29-1/2	22
1107-5	5	3-5/16	28-1/4	36	24
1107-6	6	3-5/16	35-1/2	42-1/2	31
1107-7	7	3-5/16	37	49	34
1107-8	8	3-5/16	38-1/2	55-1/2	39
1107-10	10	3-5/16	52-3/4	69	52
1107-12	12	3-5/16	55-3/4	79-1/2	63

SERIES 305					
Cat. No.	Size (ft)	Step Size (in)	Bottom Width (in)	Approx. Spread (in)	Approx. Wt. (lbs)
305-04	4	3-5/16	18-3/4	35	29
305-05	5	3-5/16	20-1/4	42	37
305-06	6	3-5/16	21-3/4	50	43
305-08	8	3-5/16	24-3/4	65	58
305-10	10	3-5/16	27-3/4	80	72
305-12	12	3-5/16	30-3/4	95	86

All Rails: 1" x 3-1/4"

SERIES 005					
Cat. No.	Size (ft)	Step Size (in)	Bottom Width (in)	Approx. Spread (in)	Approx. Wt. (lbs)
005-04	4	3-5/16	18-3/4	35	26
005-05	5	3-5/16	20-1/4	42	33
005-06	6	3-5/16	21-3/4	50	39
005-08	8	3-5/16	24-3/4	65	52
005-10	10	3-5/16	27-3/4	80	65
005-12	12	3-5/16	30-3/4	95	78

All Rails: 1" x 2-3/4"

Series 170 Wood Platform Ladder

Type IA Extra Heavy Duty 300 Lb. Duty Ladder

- **Large, Stable Platform** - Platform surface is a full 20" x 14-1/4". The platform locks the ladder in place when in the open position.
- **Top Rail Guard** - Cross brace creates a convenient railing for working from the platform.
- **Grooved Steps** - Deep grooves are precision milled into each step to help prevent slipping. Steel knee braces on every step provide lateral rigidity.
- **Steel Truss Rods** - Each step is supported by a full-width truss rod, grooved into the bottom of the step to prevent snagging or damage.



Cat. No.	Size † (ft)	Step Size (in)	Bottom Width (in)	Approx. Spread (in)	Approx. Wt. (lbs)
170-04	4	3-5/16	23-1/4	41	34
170-06	6	3-5/16	26-1/4	50	46
170-08	8	3-5/16	29-1/4	61	58
170-10	10	3-5/16	32-1/4	74	72
170-12*	12	3-5/16	35-1/4	85	88

† Size is equal to distance from floor to top of platform.
Front Rail: 1" x 3-1/4" Back Rail: 1" x 2-1/2"
*Front Rail: 1" x 3-1/4" Back Rail: 1" x 2-3/4"

Series 166 Wood Extension Ladder (Parallel Sides)

Type IA Extra Heavy Duty 300 Lb. Duty Rating

Series 180 Wood Extension Ladder (Flared Base)

Type IA Extra Heavy Duty 300 Lb. Duty Rating

- **Steel Rung Lock** - Made of heavy gauge steel for positive locking action and long service life.
- **Double Slide Guides** - Heavy duty steel slide guides are specially formed to clear the truss rod escutcheons and provide smooth sliding action.
- **Heavy Duty Pulley and Rope** - Designed to pull easily without binding or chafing. Poly rope is highly resistant to rotting and fraying.
- **Steel Truss Rods** - Each hardwood rung is supported by a steel truss rod for greater durability.
- **Optional Configuration** - Available as single section in lengths from 8' to 20'.

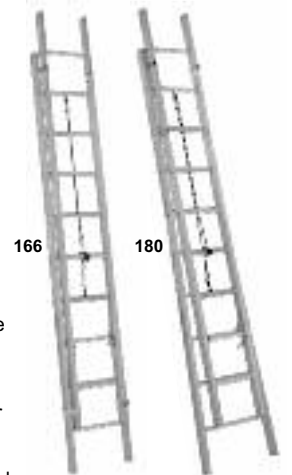

166

180

SERIES 166			
Outside Width: Base: 19-1/4"		Fly: 15-7/8"	
Inside Width: Base: 16-1/2"		Fly: 13-1/8"	
Cat. No.	Size (ft)	Rung Size (in)	Approx. Wt. (in)
166-16	16	1-1/8	33
166-20	20	1-1/8	42
166-24	24	1-1/8	50
166-28	28	1-1/8	66
166-32*	32	1-1/8	75
166-36*	36	1-1/8	88
166-40*	40	1-1/8	98

Single Section: Series 156
*Type 1,250 lb. Duty Rating

SERIES 180			
Outside Width: Base: 21-5/8"		Fly: 13-1/8"	
Inside Width: Base: 24-3/8"		Fly: 15-7/8"	
Cat. No.	Size (ft)	Step Size (in)	Approx. Wt. (in)
180-16	16	1-1/8	33
180-20	20	1-1/8	42
180-24	24	1-1/8	50
180-28	28	1-1/8	66
180-32*	32	1-1/8	75
180-36*	36	1-1/8	88
180-40*	40	1-1/8	98

Single Section: Series 190
*Type 1,250 lb. Duty Rating

Green Bull Ladders

Series 090 Wood Extension Trestle Ladder

Type IA Extra Heavy Duty 300 Lb. Duty Rating

- **Locking Bail** - Hinged locks allow the fly to be raised and lowered in 12" increments without closing the trestle.
- **Steel Center Guides** - Precision-formed steel guides secure the fly in the vertical position while allowing easy up and down adjustment.
- **Reinforcing Bar** - Vertical wood bar ties the lower rungs together for added strength in these extra wide members.
- **Steel Knee Braces** - Formed angle braces on bottom rung provide lateral rigidity and stability.



Cat. No.	Size (ft)	Rung Size (in)	Bottom Width (in)	Approx. Spread (in)	Approx. Wt. (in)	Max. Ext'D Lgth (ft)
090-06	6	1-1/8	30-1/4	46	51	9
090-08	8	1-1/8	33-1/4	60	69	13
090-10	10	1-1/8	37-1/4	74-3/4	84	15
090-12	12	1-1/8*	40-3/4	80	103	19

*Longer rungs are 1-1/4" in diameter.

Series MR Wood Extension Plank

300 Lb. Duty Rating

- **Heavy Duty Extension Plank for One-Man Use**
- **Stop Prevents Over-Extending**
- **Formed Steel End Brackets** - Keeps rails in perfect alignment, while protecting the ends from damage and wear.



Cat. No.	Size (ft)	Width (in)	Approx. Wt. (lbs)	Extended Lgth (ft)
MR-04	4	11-3/4	20	6-1/2
MR-06	6	11-3/4	30	10
MR-08	8	11-3/4	40	13-1/2
MR-10	10	11-3/4	50	17-1/2

ALUMINUM/WOOD:

Aluminum/Plywood Scaffold Board

- **Wrap-Around Channel** - Protects, supports and strengthens wood.
- **Heavy Gauge Heat-Treated Structural Aluminum Alloy Siderails and Cross Braces.**
- **1/2" Exterior Plywood Walking Surface.**
- **Four-Bolt Hook Attachment** - For extra security and extended durability.
- **Wind Latch** - Anchors the board to scaffold pipe at each end.
- Meets or Exceeds OSHA requirements.
- Available Lengths: 5', 6', 7', 8' and 10'.

Cat. No.	Size (ft)	Wt. (lbs)	Width (in)
510507	5	22	19-1/4
510607	6	26	19-1/4
510707	7	30	19-1/4
510807	8	36	19-1/4
511007	10	47	19-1/4

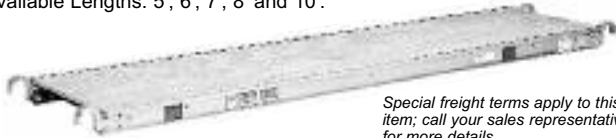

Special freight terms apply to this item; call your sales representative for more details.

All Aluminum Scaffold Board

- **Heavy Gauge Heat-Treated Structural Aluminum Alloy** - Provides a durable, non-flammable deck.
- **Integral "I"-Beam Construction** - Gives solid support and minimum flexing.
- **Wind Latch** - Anchors the board to scaffold pipe at each end.
- Hooks accommodate 1.66" and 2" O.D. pipe.
- Meets or Exceeds OSHA requirements.
- Available Lengths: 5', 6', 7', 8' and 10'.

Cat. No.	Size (ft)	Wt. (lbs)	Width (in)
510522	5	22	19-1/4
510622	6	26	19-1/4
510722	7	30	19-1/4
510822	8	33	19-1/4
511022	10	41	19-1/4

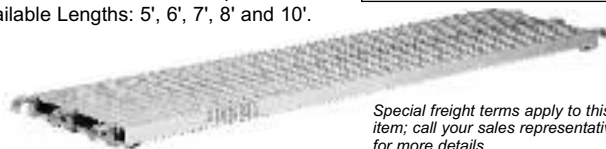

Special freight terms apply to this item; call your sales representative for more details.

ACCESSORIES:

Model No.	Description
ALUMINUM LADDER JACKS:	
290007	Short body ladder jack/pair
290008	Long body ladder jack/pair
290010	3-rung long body ladder jack/pair
FOR EXTENSION LADDERS:	
Fiberglass Ladders Only	
ACE105	Cablehook/ pole grip assembly/pair
ACE110	Rigid pole grip/each
ACE125	Wheel spurs/pair
ACE130	Rail wear sleeve/pair
Fiberglass & Wood Ladders Only	
ACE100	Swivel cable hooks/pair
Fiberglass & Aluminum Ladders Only	
ACE140	Roof hooks/pair
Wood Ladders Only	
ACE300	Swivel shoes/pair
ACE305	Rubber shoes/pair
ACE310	Wood extension ladder preservative
Fiberglass, Aluminum & Wood Ladders	
ACE115	Web pole grip/each
ACE120	Pole lash/each
ACE135	Ladder mitts/pair
ACE145	Roof hooks - mountable/pair
ACE150	Manual adjusting leg leveler/pair
ACE155	Automatic adjusting leg leveler/pair

Model No.	Description
ACE160	Fixed stand-off/each
ACE165	Adjustable stand-off/each
FOR STEP LADDERS:	
Aluminum & Fiberglass Ladders Only	
ACS200	Pail shelf/each
ACS205	Grate shoe/set of 4
Wood Ladders Only	
ACS205	Grate shoes/set of 4
ACS400	Slip-resistant shoes/set of 4 A: Series 005, 010, 300, 305 B: Series 020, 055 C: Series 025, 040
ACS405	Pail shelf/each
ACS410	Mud blocks/set of 4
ACS415	Wood step ladder preservative
FOR PLANKS AND RAIL SYSTEMS:	
290300	Aluminum guardrail/midrail tubing
290305	Aluminum toeboard material
290310	Aluminum stanchion post assembly with socket and mounting hardware
290320	2-1/2" socket with mounting hardware
290340	Small U-bolt w/wing nuts for guard/midrail
290345	Large U-bolt w/wing nuts for toeboard



290007 Short body ladder jack



290008 Long body ladder jack

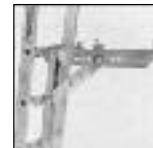

290010 3-rung long body ladder jack



ACE125 Wheel spurs

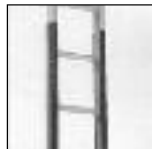

ACE130 Rail wear sleeve

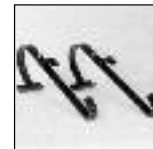

ACE140 Roof hooks



ACE100 Swivel cable hooks



ACE105 Cable hook/pole grip assy.



ACE300 Swivel shoes

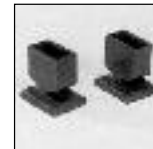

ACE305 Rubber shoes



ACE110 Rigid pole grip



ACE115 Web pole grip



ACE120 Pole lash

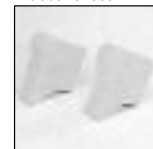

ACE135 Ladder mitts



ACE145 Roof hooks



ACE150 Manual adj. leg leveler



ACE155 Auto adj. leg leveler



ACE160 Fixed stand-off

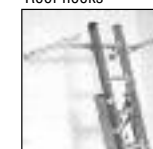

ACE165 Adj. stand-off



ACS200 Pail shelf

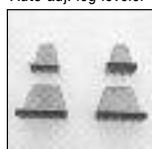

ACS205 Grate shoes



ACS400 Slip-resistant shoes

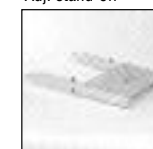

ACS405 Wood pail shelf



ACS410 - Mud blocks

Ladders

Green Bull Ladders

6' Steel Rolling Scaffold

Model #5518053
1000 Lb. Load Capacity

Consists of:

- (1) 6' plywood plank
- (2) 6' truss assemblies
- (2) 6' end frames
- (4) 5" locking casters
- (8) snap pins

WIDTH: 30" wide with casters

- Durable, exterior-grade powder coated paint is baked on for superior scuff-resistant finish.
- * Exterior-grade plywood plank with steel edge banding to protect on all 4 sides. Handle holes on each side provide ease in handling. Held in place with four spring-loaded retaining clips.
- * Spring-activated locking pin with rotating lock knob to prevent the lock from disengaging. Additional snap pin provides a dual-locked scaffold system.
- * Stacking pin with hole for locking the top unit to the base unit.
- * 5" swivel casters with dual brakes to prevent both rolling and swiveling when in use. Additional snap pin to secure the caster to the unit.



5' Steel Rolling Scaffold

Model #5518052
1000 Lb. Load Capacity

Consists of:

- (1) 5' plywood plank
- (2) 5' truss assemblies
- (2) 5' end frames
- (4) 5" locking casters
- (8) snap pins

- Durable, exterior-grade powder coated paint is baked on for superior scuff-resistant finish.
- * Easy-grip locking pin with additional snap pin to create dual-locked scaffold system.
- * Exterior-grade plywood plank with steel edge banding to protect on all 4 sides. Handle holes on each end provide ease in handling. Held in place with 4 spring-loaded retaining clips.
- * 5" swivel casters with dual brakes to prevent both rolling and swiveling when in use. Additional snap pin to secure the caster to the unit.
- * Narrow 25" width (with casters) is ideal for residential or commercial work. Easy to maneuver in smaller work areas.



Steel Outriggers (Set of 4)

Model #5518045

Consists of:

- (4) outriggers
- (8) snap pins
- (5" casters sold separately)

- Durable, exterior-grade powder coated paint is baked on for superior scuff-resistant finish.
- Easy to install with two snap pins and a thumb screw.
- Outriggers are required when stacking units over 6' (up to 12' high).
- (NEVER stack more than one unit to the base unit)



6' Steel Guard Rail With Wood Toeboard

Model #5518039

Consists of:

- (2) guardrail sides
- (2) guardrail ends with midrail access chain
- (2) toeboard sides
- (2) toeboard ends
- (4) toeboard retaining brackets
- (4) snap pins

- Durable, exterior-grade powder coated paint is baked on for superior scuff-resistant finish.
- Removable safety chain on both ends provides easy access to the work platform.
- Guardrail is required when work platform is more than 10' above the floor.



4' Steel Mini-Fold Workstand

Model #5559011
400 Lb. Load Capacity

Consists of:

- (1) 4' folding frame
- (2) aluminum planks
- (4) 5" locking casters & mounting hardware

- Durable, exterior-grade powder coated paint is baked on for superior scuff-resistant finish.
- Corrosive resistant aluminum plank with serrated, slip-resistant surface. 9-3/4" wide with steel end hooks. Planks can be placed at four different levels.
- 5" swivel casters with dual brakes to prevent both rolling and swiveling when in use.
- One-piece folding assembly provides for quick and easy set-up and tear-down. Folds for compact storage.

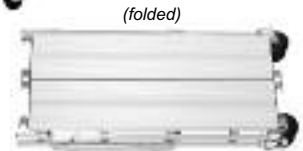

(folded)

Steel Drywall Cart

Model #5575002
3,000 Lb. Load Capacity

- Ideal for moving drywall, glass, plywood and other panel products easily on 8" swivel casters
- Durable, exterior-grade powder coated paint is baked on for superior scuff-resistant finish.



Werner® Ladders

Fiberglass Flat D-Rung Extension Ladders D7500-2 Series

Type 1A Extra Heavy Duty/Professional Use - 300 lb. Load Capacity

Hi-strength nylon coated guides at top of base section reduce friction for ease of operation

Mar-resistant molded end caps, vinyl coated aluminum hoop end caps on 36' and 40' models

Pre-pierced holes for easy field installation of accessories

Model D7520-2

Single pulley system; double pulley system on 36' and 40' models

Base and fly separate easily to use base section as single ladder

Plate and rung assembly are riveted at four points to each side rail to allow for rung replacement

Slip-resistant Traction-Tred® D-rungs

Rugged gravity spring locks operate smoothly

Rope clamp ties rope to rung

Durable rail shield and shoe bracket protects rail from abuse and damage

Shoe with slip-resistant pad & spur plate

Non-separable sections on 36' and 40' models

Nylon coated internal guides on bottom of fly section increase ease of operation

Dimensions: 16' to 32'
Rails: 3-1/2" wide
Flange: 1-3/16" wide
Rungs: 1-3/4"
Fly Width: 16-1/8" outside rails
Base Width: 20-1/4" outside shoes

Dimensions: 36' and 40'
Rails: 4" wide
Flange: 1-3/4" wide
Rungs: 1-3/4"
Fly Width: 16-3/4" outside rails
Base Width: 22" outside shoes

Model No.	Total Length Sections (ft)	Max. Working Length (ft)	Approx. Cu. Ft. Per Unit	Approx. Ship. Wt. (lbs)
D7516-2*	16	13	7.9	45.0
D7520-2	20	17	9.8	53.0
D7524-2	24	21	11.6	62.0
D7528-2	28	25	13.5	70.0
D7532-2	32	29	15.4	81.0
D7536-2	36	32	23.8	114.0
D7540-2	40	35	26.7	128.0

*Note: D7516-2 is not equipped with rope and pulley

Exclusive Alflo® rung joint means Twist-Proof® performance

Fiberglass Extension Trestle Ladders†† E7400 Series

Type 1A Extra Heavy Duty/Professional Use - 300 lb. Load Capacity

Extended ladder height

Accommodates 12" or 14" wide stage or plank

Slip-resistant Traction-Tred® round rungs

Spring-loaded locking mechanism

Heavy duty aluminum top

Slip-resistant Traction-Tred® extra wide steps are knee-braced and triple riveted

Double braced bottom step

Use guy lines when height of platform exceeds 3 times the bottom width of base section

Nylon coated guide sleeves assure minimum friction and wear, increase ease of operation

Extra heavy duty internal spreaders

Shoe with rubber tread and protective rail shields

Combination rail end shield and foot with slip-resistant rubber foot pad

Non-conductive rail shields reinforce bottom ends for increased resistance to damage and abuse

Model E7408

Model No.	Step-ladder Size (ft)	Base Section Bottom Width (in)	Approx. Spread (in)	Approx. Extended Ladder Height (ft)	Approx. Cu. Ft. Per Unit	Approx. Ship. Wt. (lbs)
E7408	8	32-3/4	67-3/4	12	16.6	73.0
E7410	10	36-1/4	81-7/8	15	22.2	94.0
E7412	12	39-3/4	95-7/8	19	28.3	112.0
E7414	14	43-1/4	109-3/4	22	35.1	134.0
E7416	16	46-3/4	123-3/4	26	42.4	156.0

Dimensions: Extended Ladder Step Ladder
Trestle Steps: — 3-1/4" wide
Rails: 3-3/8" wide 3-3/8" wide
Flange: 1-3/16" wide 1-3/16" wide
Rungs: 1-1/4" —

†† Designed for one or two person jobs. Note: When used as a double stepladder, the maximum load per side, including person and materials, shall not exceed the duty rating of ladder.

Fiberglass Flat D-Rung Extension Ladders D7100-2 Series

Type 1A Extra Heavy Duty/Professional Use - 300 lb. Load Capacity

External guides at top of base section securely interlock rails

Mar-resistant molded end caps

Pre-pierced holes for easy field installation of accessories

Model D7124-2

Heavy duty pulley with rope

Plate and rung assembly are riveted at four points to each side rail to allow for rung replacement

Slip-resistant Traction-Tred® D-rungs

Rugged gravity spring locks operate smoothly

Rope clamp ties rope to rung

Durable rail shield and shoe bracket protects rail from abuse and damage

Interlocking side rails

Base and fly separate easily to use base section as single ladder

Nylon coated internal guides on bottom of fly section increase ease of operation

Dimensions: 16' to 32'
Rails: 3-5/16" wide
Flange: 1-3/16" wide
Rungs: 1-1/2"
Fly Width: 16-1/8" outside rails
Base Width: 19" outside shoes

Model No.	Total Length Sections (ft)	Max. Working Length (ft)	Approx. Cu. Ft. Per Unit	Approx. Ship. Wt. (lbs)
D7116-2*	16	13	7.0	41.0
D7120-2	20	17	8.7	49.0
D7124-2	24	21	10.3	58.0
D7128-2	28	25	12.0	66.0
D7132-2	32	29	13.7	79.0

*Note: D7116-2 is not equipped with rope and pulley

Exclusive Alflo® rung joint means Twist-Proof® performance

Shoe w/ slip-resistant pad and spur plate

Ladders

Werner® Ladders

**Aluminum Flat D-Rung Extension & Single Ladders
D1500-2/D1500-1 Series**

Type 1A Extra Heavy Duty/Professional Use - 300 lb. Load Capacity

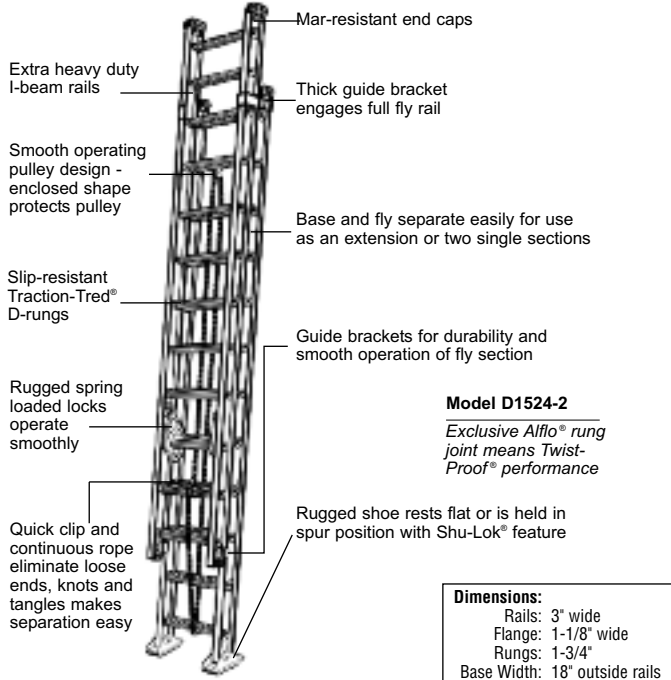

Model D1524-2
Exclusive Alflo® rung joint means Twist-Proof® performance

Dimensions:
Rails: 3" wide
Flange: 1-1/8" wide
Rungs: 1-3/4"
Base Width: 18" outside rails

Model No.	Total Length Sections (ft)	Max. Working Length (ft)	Approx. Cu. Ft. Per Unit	Approx. Shipping Wt. (lbs)	Model No.	Total Length (ft)	Approx. Cu. Ft. Per Unit	Approx. Shipping Wt. (lbs)
D1516-2†	16	13	6.2	31.0	D1508-1	8	3.6	14.0
D1520-2	20	17	7.7	37.0	D1510-1	10	4.5	17.0
D1524-2	24	21	9.2	45.0	D1512-1	12	5.4	21.0
D1528-2	28	25	10.7	56.0	D1514-1	14	6.2	26.0
D1532-2	32	29	12.2	66.0	D1516-1	16	7.1	32.0
D1536-2	36	32	13.7	79.0	D1518-1**	18	8.0	38.0
D1540-2	40	35	15.2	89.0	D1520-1	20	8.9	43.0

† Note: D1516-2 is not equipped with rope and pulley

Aluminum Modular Systems for Aluminum Stages

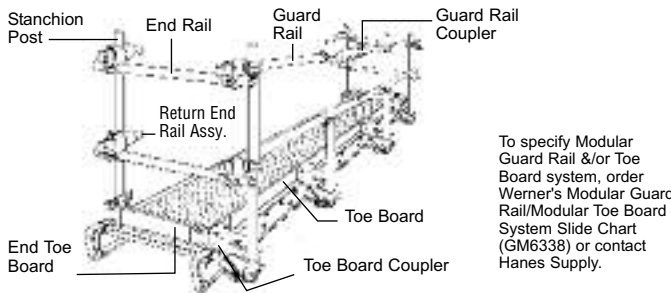

To specify Modular Guard Rail &/or Toe Board system, order Werner's Modular Guard Rail/Modular Toe Board System Slide Chart (GM6338) or contact Hanes Supply.

Toe Board Systems	Kit No.	Lgth.	Pkg. Qty.	Approx. Ship. Wt. (lbs)
Toe Board Coupler Assy.	TB2-1 TB3-1	- -	2 3	2.0 3.0
Toe Board	TB05-1 TB06-1 TB07-1 TB08-1	5' 6' 7' 8'	1 1 1 1	4.0 5.0 6.0 7.0
End Toe Board Assy.	ETB12-1 ETB14-1 ETB20-1 ETB24-1 ETB28-1 ETB30-1	12" 14" 20" 24" 28" 30"	2 2 2 2 2 2	3.0 3.0 4.0 5.0 6.0 6.0
Independent Toe Board Bracket Assy.	ITB2-1 ITB3-1	- -	2 3	5.0 7.0

Guard Rail Systems	Kit No.	Lgth. (in)	Pkg. Qty.	Approx. Ship. Wt. (lbs)
Stanchion Post Assy.	SP2-1 SP3-1	- -	2 3	16.0 24.0
End Rail Assembly	ER28-1 ER34-1 ER40-1	28 34 40	4 4 4	14.0 15.5 17.0
Return End Rail Assy.	RR24-1	-	4	6.5
Guard Rail	GR06-1 GR08-1 GR12-1	6 8 12	1 1 1	5.0 5.0 5.0
Guard Rail Coupler Assy.	RC-1	-	1	1.5

Task-Master® Stages

Ideal for ladder jack applications, swing stages, or catwalks

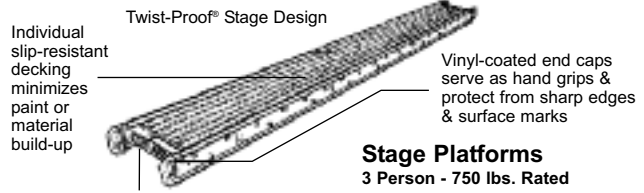

Double end rung provides extra rigidity on stages 20' or longer- standard on stages with 5" or 6" rails

**Stage Platforms
2 Person - 500 lbs. Rated**

Model No.	Width (in)	Side Rail Length (ft)	Side Rail Depth (in)	Side Rail Flange (in)	Approx. Ship. Wt. (lbs)
2508	20	8	4	1-3/8	33
2512	20	12	4	1-3/8	48
2516	20	16	5	1-3/8	70
*2520	20	20	6	1-3/8	102
*2524	20	24	6	1-3/8	121
*2528	20	28	6	2	157
*2530	20	30	6	2	168
*2532	20	32	6	2	179
*2536	20	36	6" HD	2	243
*2539	20	39	6" HD	2	264
2608	24	8	4	1-3/8	38
2612	24	12	4	1-3/8	56
2616	24	16	5	1-3/8	81
*2620	24	20	6	1-3/8	115
*2624	24	24	6	1-3/8	138
*2628	24	28	6	2	168
*2630	24	30	6	2	180
*2632	24	32	6	2	191
*2636	24	36	6" HD	2	258
*2639	24	39	6" HD	2	280
2708	28	8	4	1-3/8	41
2712	28	12	4	1-3/8	60
2716	28	16	5	1-3/8	87
*2720	28	20	6	1-3/8	124
*2724	28	24	6	1-3/8	147
*2728	28	28	6	2	187
*2730	28	30	6	2	200
*2732	28	32	6	2	213
*2736	28	36	6" HD	2	282
*2739	28	39	6" HD	2	307

Decorator Planks

1 Person - 250 lbs. Rated

Model No.	Width (in)	Side Rail Length (ft)	Side Rail Depth (in)	Side Rail Flange (in)	Approx. Ship. Wt. (lbs)
2008	12	8	4	1-3/8	25
2012	12	12	4	1-3/8	36
2016	12	16	4	1-3/8	48
2020	12	20	5	1-3/8	65
2024	12	24	5	1-3/8	78
2108	20	8	4	1-3/8	33
2112	20	12	4	1-3/8	48
2116	20	16	4	1-3/8	64
2120	20	20	5	1-3/8	87
2124	20	24	5	1-3/8	104

**Stage Platforms
3 Person - 750 lbs. Rated**

Model No.	Width (in)	Side Rail Length (ft)	Side Rail Depth (in)	Side Rail Flange (in)	Approx. Ship. Wt. (lbs)
3008	20	8	4	2	40
3012	20	12	4	2	59
*3016	20	16	5	2	86
*3020	20	20	6	2	107
*3024	20	24	6	2	135
*3028	20	28	6" HD	2	189
*3030	20	30	6" HD	2	206
*3032	20	32	6" HD	2	219
3108	24	8	4	2	43
3112	24	12	4	2	64
3116	24	16	5	2	92
*3120	24	20	5	2	115
*3124	24	24	6	2	145
*3128	24	28	6" HD	2	204
*3130	24	30	6" HD	2	222
*3132	24	32	6" HD	2	236
*3136	24	36	6" HD	2	323
*3139	24	39	6" HD	2	365
3208	28	8	4	2	48
3212	28	12	4	2	71
3216	28	16	5	2	103
3220	28	20	5	2	128
*3224	28	24	6	2	161
*3228	28	28	6" HD	2	220
*3230	28	30	6" HD	2	236
*3232	28	32	6" HD	2	251
*3236†	28	36	6" HD	2	344
*3239†	28	39	6" HD	2	388

Scaffold Planks

2 Person - 500 lbs. Rated

Model No.	Width (in)	Side Rail Length (ft)	Side Rail Depth (in)	Side Rail Flange (in)	Approx. Ship. Wt. (lbs)
2316	12	16	4	1-3/8	48
2320	12	20	6	1-3/8	79
2324	12	24	6" HD	1-3/8	112
2328	12	28	6" HD	1-3/8	131
2330	12	30	6" HD	1-3/8	140
2332	12	32	6" HD	1-3/8	149
2408	14	8	4	1-3/8	27
2412	14	12	4	1-3/8	40
2416	14	16	5	1-3/8	58
2420	14	20	6	1-3/8	85
2424	14	24	6	2	109
2428	14	28	6	2	127
2430	14	30	6" HD	2	171
2432	14	32	6" HD	2	182

HD = Heavy Duty

* Includes set of double rungs at the end of stage.

† Includes reinforcing channel

18
Ladders

Werner® Ladders

Fiberglass Twin Step Stool†† - Model T6202

Type 1A Extra Heavy Duty/Professional Use - 300 lb. Load Capacity

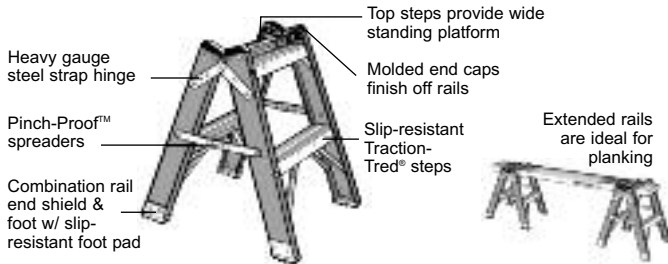

- Folds to 7-1/2" width for easy storage
- Every rivet backed up by metal part or washer to protect rails

Dimensions:	Model No.	Size (ft)	Approx. Width (in)	Approx. Spread (in)	Approx. Cu. Ft. Per Unit	Approx. Ship. Wt. (lbs)
Steps: 3" wide Rails: 3-1/8" wide Flange: 1-3/16" wide	T6202	2	21-1/8	23	2.1	12.0

†† Designed for one or two person jobs. Note: When used as a double step stool, the maximum load per side, including person and materials, shall not exceed the duty rating of ladder. Note: Planks or platforms shall be secured to the step stools. The ends of each plank or platform shall extend beyond the outside edge of each step stool by a minimum of 4 inches & a maximum of 10 inches.

Wood (Pine) Twin Step Stool†† Model WT302-2

Type 1 Heavy Duty/Industrial Use - 250 lb. Load Capacity

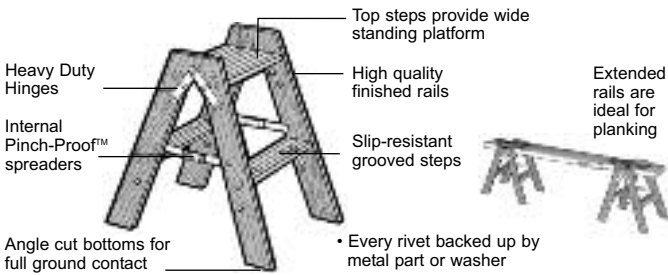

- Every rivet backed up by metal part or washer

Nominal Dimensions:	Model No.	Size (ft)	Approx. Width (in)	Approx. Spread (in)	Approx. Cu. Ft. Per Unit	Approx. Ship. Wt. (lbs)
Steps: 3/4" x 3-5/8" Rails: 3/4" x 3-1/2"	WT302-2 (2-pack)	2	19-1/2	22-3/4	2.0	12.5 ea.

†† Designed for one or two person jobs. Note: When used as a double step stool, the maximum load per side, including person and materials, shall not exceed the duty rating of ladder. Note: Planks or platforms shall be secured to the step stools. The ends of each plank or platform shall extend beyond the outside edge of each step stool by a minimum of 4 inches and a maximum of 10 inches.

Aluminum Project Buddy™ Mobile Work Platform - Model 3954

Maximum Load = 500 lbs.

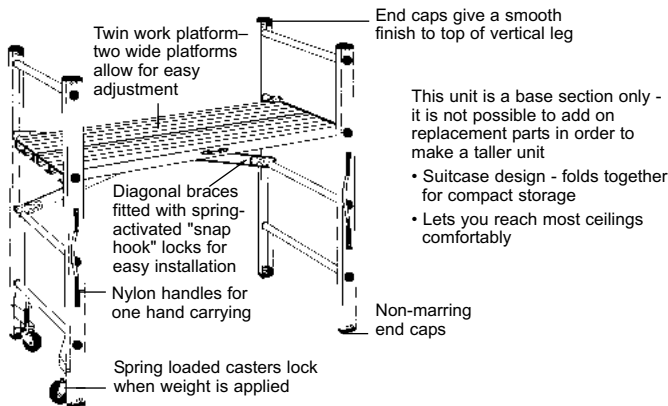

- Suitcase design - folds together for compact storage
- Lets you reach most ceilings comfortably

Dimensions:	Model No.	Approx. Ht. (ft)	Approx. Width (in)	Approx. Length (ft)	Approx. Cu. Ft. Per Unit	Approx. Shipping Wt. (lbs)
Platform: 8-3/4 sq. ft. of work area Rails: 2-1/2" wide Flange: 1" wide	3954	4	23	4	4.2	37.0

Note 1: Replacement plank P/N 56842-01 available.
Note 2: Replacement x-brace PN 56844-01 available.

Aluminum Contractor Buddy® Mobile Work Platform - Model 4154 & 4156

Maximum Load = 750 lbs.

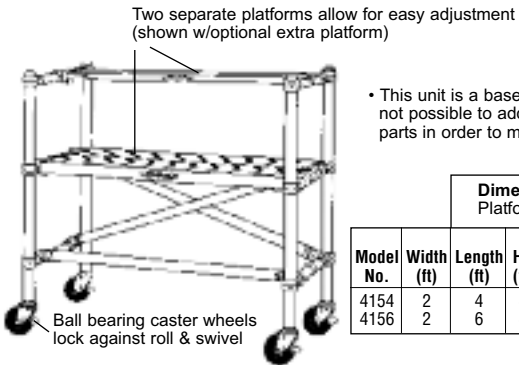

- This unit is a base section only - it is not possible to add on replacement parts in order to make a taller unit.

Dimensions: Platform: 9-1/2 ft. wide						
Model No.	Width (ft)	Length (ft)	Ht. (ft)	Approx. Cu. Ft. Per Unit	Approx. Shipping Wt. (lbs)	
4154	2	4	4	6.9	62.0	
4156	2	6	4	10.2	73.0	

ALDEK® SPAN SCAFFOLDS:

4200 Series Wide Span

Aluminum. Load Capacity: 25 lbs. per sq. ft. or 500 lbs. maximum per deck and 1000 lbs. maximum per scaffold

Model No.	Width (ft)	Length (ft)	Approx. Shipping Wt. (lbs)
3-1/2' High Guard Rail			
4210	4-1/2	6	55.0
4211	4-1/2	8	60.0
4212	4-1/2	10	65.0
4' High Upper Section			
4207	4-1/2	6	62.0
4208	4-1/2	8	68.0
4209	4-1/2	10	73.0
5-1/2' High Upper Section			
4204	4-1/2	6	71.0
4205	4-1/2	8	76.0
4206	4-1/2	10	81.0
6-1/2' to 7-1/2' High Base Section			
4201	4-1/2	6	167.0
4202	4-1/2	8	188.0
4203	4-1/2	10	208.0

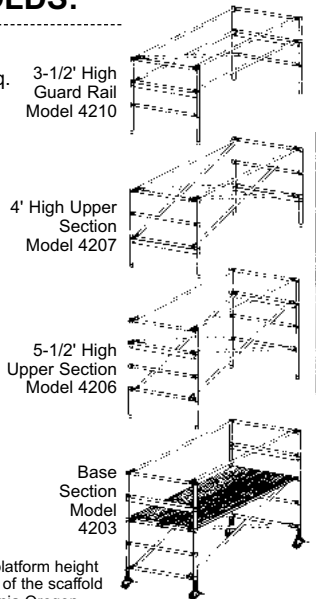

NOTICE - ALL SCAFFOLDS: Maximum scaffold platform height is equal to 4x the smaller base section dimension of the scaffold or installed outrigger in most states except California, Oregon, Ohio, Montana, Maine, which require 3x and Washington which requires 3-1/2x. Check state and local codes.

4100 Series Narrow Span

Aluminum. Load Capacity: 25 lbs. per sq. ft. or 500 lbs. maximum per deck and scaffold

Model No.	Width (in)	Length (ft)	Approx. Shipping Wt. (lbs)
3-1/2' High Guard Rail			
4110	29	6	44.0
4111	29	8	48.0
4112	29	10	52.0
4' High Upper Section			
4107	29	6	47.0
4108	29	8	51.0
4109	29	10	55.0
5-1/2' High Upper Section			
4104	29	6	53.0
4105	29	8	58.0
4106	29	10	62.0
6-3/4' High Upper Section			
4127	29	6	60.0
4128	29	8	65.0
4129	29	10	68.0
6-1/2' to 7-1/2' High Adj. Base Section			
4101	29	6	121.0
4102	29	8	133.0
4103	29	10	145.0

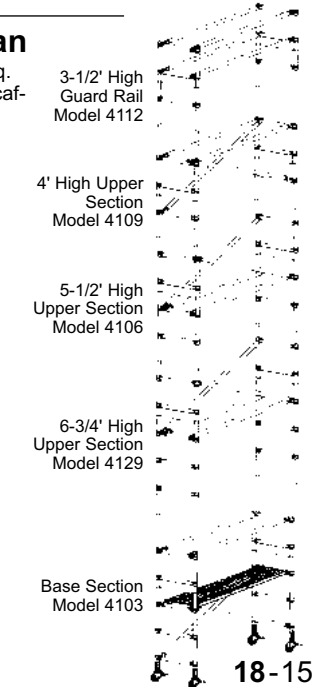

Ladders

Werner® Ladders

4000 Series Stairway

Aluminum. Load Capacity: 50 lbs. per sq. ft. or 1300 lbs. maximum per scaffold (Except model 4005 - Load Capacity: 25 lbs. per sq. ft./650 lbs. max. per scaffold)

Model No.	Width (in)	Length (ft)	Approx. Shipping Wt. (lbs)
3-1/2' High Guard Rail			
4003	29	6	57.0
3-1/2' High Upper Section			
4004	29	6	64.0
6' High Upper Section			
4002	29	6	102.0
6-3/4' to 7-3/4' High Adj. Base Section			
4001	29	6	147.0

Toe Board Systems

OSHA requires toe boards on Scaffolds over 10'

Model No.	Size (in x ft)	Wt. (lbs)	Model No.	Size (in x ft)	Wt. (lbs)
Aluminum Toe Board Assy. for 4000 Series					
T4000-4	2' x 6'	14.0	-	-	-
Wood Toe Board Assy. for 4100 Series					
T4101-4	4' x 6'	21.0	T4101-6	6' x 6'	29.0
T4102-4	4' x 8'	26.0	T4102-6	6' x 8'	36.0
T4103-4	4' x 10'	31.0	T4103-6	6' x 10'	43.0
Wood Toe Board Assy. for 4200 Series					
T4201-4	4' x 6'	24.0	T4201-6	6' x 6'	35.0
T4202-4	4' x 8'	30.0	T4202-6	6' x 8'	42.0
T4203-4	4' x 10'	35.0	T4203-6	6' x 10'	49.0

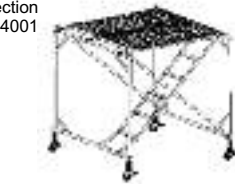
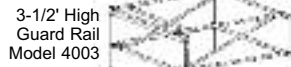

Toe Board System

Outriggers - For Wide, Narrow & Stairway Span Scaffolds (Aluminum)

Model No.	Used on Scaffold	Wt. (lbs)
Clamp on Outriggers Pairs, 1-sided base outrigger		
6'4" wide for narrow span scaffolds		
8'5" wide for wide span scaffolds		
4117	4101, 4113, 4201	50.0
4119	4102, 4114, 4202	51.0
4121	4103, 4115, 4203	55.0
Rolling Outriggers Supports, 2-sided base outrigger		
4118	4101, 4113, 4201	96.0
4120	4102, 4114, 4202	97.0
4122	4103, 4115, 4203	105.0
Model No. Scaffold Length Wt. (lbs)		
Rolling Clamp on Outriggers		
4011 (1-sided)	ALL	53.0
4012 (2-sided)	ALL	98.0
Clamp on Outrigger		
80" wide		
4116	ALL	26.0
Knee-Type Outriggers		
Adjustable 1' to 5'6" wide for narrow or wide span scaffolds		
4123 (1 pair)	ALL	21.0



Rolling Outriggers (Pair of 2) Model 4117



Rolling Outriggers (Set of 4) Model 4118



Outriggers (Set of 4) Model 4012

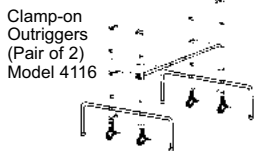

Clamp-on Outriggers (Pair of 2) Model 4116

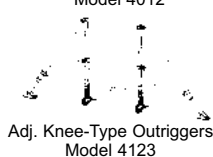

Adj. Knee-Type Outriggers Model 4123

High Clearance Base Stairway Scaffold

Aluminum. Load capacity: 25 lbs. per sq. ft./ 650 lbs. max. per scaffold
• Adjustable 6-1/2' to 7-1/2' high clearance

Model No.	Width (ft)	Length (ft)	Wt. (lbs)
4005	4-1/2	6	157.0

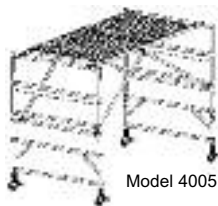

Model 4005

High Clearance Narrow Span Scaffold Bases

Aluminum. Load capacity: 25 lbs. per sq. ft., or 500 lbs. max. per deck & scaffold
• Adjustable 6-1/2' to 7-1/2' high clearance

Model No.	Width (in)	Length (ft)	Wt. (lbs)
4113	29	6	121.0
4114	29	8	139.0
4115	29	10	151.0

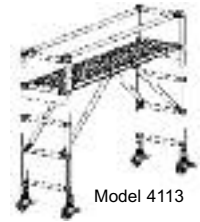

Model 4113

Snap-In Scaffold Ladder

Aluminum.

Model No.	For Use With Series	Length (ft/in)	Wt. (lbs)
45-1	4100, 4200	5'8"	10.0
45-2	4100, 4200	7'8"	13.0



Model 45-1

Snap-Up® Narrow Span Folding Scaffolds

Aluminum. Load capacity: 25 lbs. per sq. ft. or 500 lbs. max. per deck & scaffold
• Adjustable 6-3/4' to 7-3/4' high clearance

Model No.	Width (in)	Length (ft)	Wt. (lbs)
4151	29	6	127.0
4152	29	8	139.0

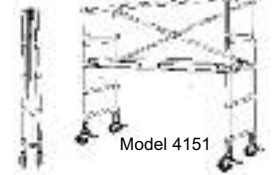

Model 4151

Snap-Up® Wide Span Folding Scaffolds

Aluminum. Load capacity: 25 lbs. per sq. ft., or 500 lbs. max. per deck & 1000 lbs. max. per scaffold
• Adjustable 6-3/4' to 7-3/4' high clearance

Model No.	Width (ft)	Length (ft)	Wt. (lbs)
4251	4-1/2	6	163.0
4252	4-1/2	8	181.0

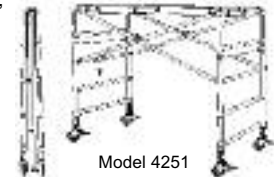

Model 4251

Work Platforms for Use on Aluminum Scaffolds Only
Plywood Decked Platform Boards for Werner's Aldek® Scaffolding

Model No.	Width (in)	Used on Scaffold	Approx. Shipping Wt. (lbs)
Access Door Platform Board Kits (User Installation)			
D22-1W	22	Any 6' Section	33.0
D22-2W	22	Any 8' Section	41.0
D22-3W	22	Any 10' Section	49.0
Access Door Platform Options (Factory Installed)			
5507-24	22	Any 6' Section	5.0
5508-24	22	Any 8' Section	5.5
5510-24	22	Any 10' Section	6.0



To order, add "X" after scaffold model no. (Ex: 4101X AD22-1W)

Werner® Ladders

ALUMINUM WORK PLATFORMS FOR USE WITH STEEL SCAFFOLDS:

2-Piece Extruded Aluma-Board - 5600 Series

Model No.	Duty Rating /Sq. Ft. (lbs)	Width (in)	Side Rail Length (ft)	Side Rail Depth (in)	Approx. Ship. Wt. (lbs)
5607-19	75	19-1/16	7	3	30.0
5608-19**	75	19-1/16	8	4	34.0
5610-19	50	19-1/16	10	4	41.0

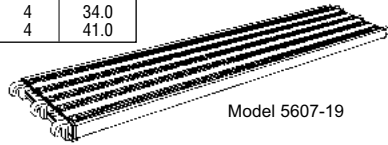

Model 5607-19

Aluminum Decked Aluma-Plank® 5500 Series

Model No.	Duty Rating /Sq. Ft. (lbs)	Width (in)	Side Rail Length (ft)	Side Rail Depth (in)	Approx. Ship. Wt. (lbs)
5507-19	75	19-1/16	7	3	25.0
5508-19**	75	19-1/16	8	4	39.0
5510-19	75	19-1/16	10	4	49.0
L5508-19**	50	19-1/16	8	4	28.0
L5510-19	50	19-1/16	10	4	36.0
5507-24	75	24	7	3	29.0
5508-24**	75	24	8	4	39.0
5510-24	75	24	10	4	49.0

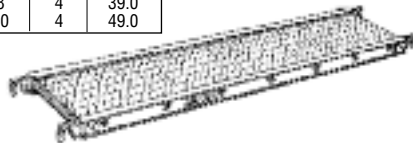

Model 5507-19

Plywood Decked Aluma-Plank® - 5300 Series

Model No.	Duty Rating /Sq. Ft. (lbs)	Width (in)	Side Rail Length (ft)	Side Rail Depth (in)	Approx. Ship. Wt. (lbs)
5307-19	75	19-1/16	7	3	27.0
5308-19	75	19-1/16	8	4	38.0
5310-19	75	19-1/16	10	4	47.0
L5308-19	50	19-1/16	8	4	30.0
L5310-19	50	19-1/16	10	4	39.0
5307-24	75	24	7	3	32.0
5308-24**	75	24	8	4	42.0
5310-24	75	24	10	4	53.0
28" Wide Solid Door					
5306-19	50	28	6	4-1/8	31.0
5307-19	50	28	7	4-1/8	36.0
5308-19**	50	28	8	4-1/2	48.0
5310-19	50	28	10	4-1/2	59.0
28" Wide Access Door					
AD5306-28**	50	28	6	4-1/8	36.0
AD5307-28**	50	28	7	4-1/8	41.0
AD5308-28**	50	28	8	4-1/2	53.0
AD5310-28**	50	28	10	4-1/2	64.0



Model AD5300-28

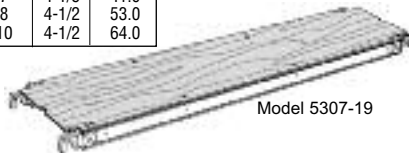

Model 5307-19

Plywood Decked Aluma-Plank® 5200 Series

Model No.	Duty Rating Sq. Ft. (lbs)	Width (in)	Side Rail Length (ft)	Side Rail Depth (in)	Approx. Ship. Wt. (lbs)
5207-19	75	19-1/16	7	3	27.0
5208-19**	75	19-1/16	8	4	38.0
5210-19	75	19-1/16	10	4	46.0

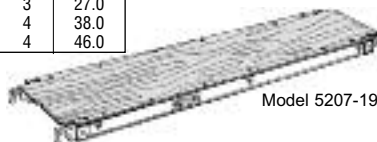

Model 5207-19

Aluma-Plank® Toe Board System

OSHA requires toe boards on scaffolds over 10'

Model No.	Aluminum Deck Applicable to Series No.	Approx. Ship. Wt. (lbs)
T5307-19	5207-19 5307-19 5507-19	16.0
T5308-19	5208-19 5308-19 5408-19	18.0
T5310-19	5210-19 5310-19 5410-19	21.0
T5307-24	5307-24 5407-24	16.0
T5308-24	5308-24 5408-24	19.0
T5310-24	5310-24 5410-24	22.0
T5306-28	5306-28	16.0
T5307-28	5307-28	17.0
T5308-28	5308-28	19.0
T5310-28	5310-28	22.0



Model No.	Aluminum Deck Applicable to Series No.	Approx. Ship. Wt. (lbs)
T5607-19	5607-19	15.5
T5608-19	5608-19	17.0
T5610-19	5610-19	20.0

Model No.	Aluminum Deck Applicable to Series No.	Approx. Ship. Wt. (lbs)
T5507-19	5507-19	16.0
T5508-19	5508-19	18.0
T5510-19	5510-19	21.0
T5507-24	5507-24	16.0
T5508-24	5508-24	19.0
T5510-24	5510-24	22.0

EXTENSION LADDERS ACCESSORIES/OPTIONS:

V-Rungs Plated steel pierced to grip wood poles. Pre-pierced holes in fiberglass top rails are provided to accept this accessory. V-rung assembly comes w/ mounting hardware and instructions.



Option No.	Fits on Fiberglass Series	Ladder Size
A70-1	7100-2 7800 D7100-2 D6200-2 D6300-2 R6200-2	ALL ALL ALL ALL ALL ALL
A70-2	7500-1 7500-2 D7500-2	8' to 16' 16' to 32' 16' to 32'
A70-3	7500-1 7500-2 D7500-2	18' to 20' 36' to 40' 36' to 40'

Approx. Shipping Weight 1.5 Lbs.
Options Approx. Added Weight to Ladder 1.5 lbs.

Kit No.	Fits on Fiberglass Series	Ladder Size
70-1	D6200-2 7100-2 D7100-2 7800	ALL ALL ALL ALL
70-2	7500-1 7500-2 D7500-2	8' to 16' 16' to 32' 36' to 40'

True Grip® Ladder Stand-Off and Surface Protectors

Protects surface from damage. Up to 50 times more contact area. Provides good support for ladder. This comes with one (1) set of stabilizers, rubber pads, fleece bonnets, mounting hardware and instructions.

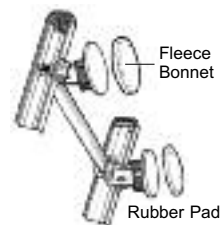

Item Packaged for display
• Fits on All Fiberglass Extension Ladders
• Fits on All Aluminum Extension Ladders

Kit No.	Ladder Size (ft)	Approx. Ship. Wt. (lbs)
17	up to 40'	3.0

Cable Hooks

Easily folds within side rails for storage. (Shown in stored position.) Cable hooks can be mounted above or below top rung. Consult us if using in conjunction with other accessories. Cable hooks come with mounting hardware and instructions.

Approx. Shipping Weight 2.6 Lbs.
options Approx. Added weight to Ladder 2.6 Lbs.

Kit No. -	Fits on Fiberglass Series	Ladder Size (ft)
74-1	7100-1, 7500-1 D6200-2, 7100-2 D7100-2 7500-2, D7500-2 7100-3	8' to 16' ALL ALL 16' to 32' 25' to 35'
74-2	7500-1 7500-2, D7500-2	18' to 20' 36' to 40'
Option No.	Fits on Fiberglass Series	Ladder Size
A74-1	7100-1, 7500-1 D6200-2, 7100-2 D7100-2 7500-2, D7500-2 7100-3 D6300-2, R6200-2	8' to 16' ALL ALL 16' to 32' 25' to 35' ALL
A74-2	7500-1 7500-2, D7500-2	18' to 20' 36' to 40'



Ladders

Hi-Lo Climbers

POWERED SCAFFOLDING SYSTEMS

Hi-Lo Climber Units

Hi-Lo Climbers powered hoists are designed for use with a wide variety of scaffolding configurations as well as individual work cages. All units feature rugged construction, dependable, proven performance and quick, simple reeving.

SAFETY FEATURES

There are four safety features built into each Hi-Lo Climbers powered scaffolding unit:

- 1. Overspeed Brake Assembly:** Automatically trips and locks the wire rope to the frame should descent speed become excessive.
- 2. Speed Reducer:** Gear box has a 30 to 1 ratio from the motor to the drive pulley shaft. Once reeved and in the air, the wire rope is locked into the speed reducer by pressure of the unit's load and the self locking fairlead.
- 3. Automatic Idle:** Stops the wire rope from paying out when the unit reaches the ground or an obstacle such as a ledge; this eliminates the danger of upsetting the suspended scaffold.
- 4. Overload Mechanism:** Automatically stops all upward movement if the unit is overloaded or catches on a protrusion.

PRIMARY FEATURES & BENEFITS:

Open Breech Reeving: Hi-Lo powered hoists can be reeved at any point along the wire rope.

Climbs Rope: No wire rope build-up on a drum. Eliminates cable weight on stage and assures constant speed.

Modular Design: Stirrup, powered hoist and overspeed safety are combined in one modular unit. Major components can be removed in minutes for maintenance or replacement. Easy interchangeability of power from electric to air.

Simple Set-Up and Operation: The same stirrup hoist assembly may be mounted quickly and easily on a variety of suspend scaffolds as well as work cages. The setup is so simple that one man can easily accomplish this task.

Service and Parts: Available worldwide.

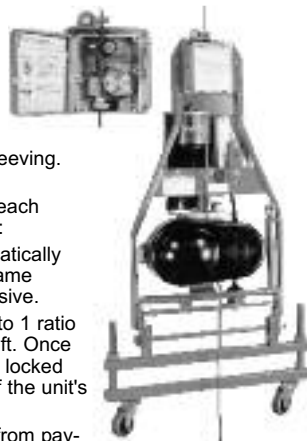

Model
FD-351 Shown

Modular Work Cage

This unit is the safe, economical solution for many small jobs. It requires little room for transport. One man can quickly assemble the work cage which provides a stable platform and good work space for a wide variety of jobs.



Standard Work Cage

Model WC-36

Rated 750 lbs. **Weight** 165 lbs.
Part 245-WC36 **Dim** 87" x 36" x 36"

The hoist is mounted at the rear of the cage. The sheave has been positioned to provide the worker with maximum space and a stable platform. The front guard rail is adjustable. Four casters on the bottom make ground transfer easy. Roller bumpers (included) protect the work surface during vertical movement.



Modular Staging Systems

Standard modular sections can be configured to meet the requirements of virtually any application. This allows work crews to handle a larger variety of jobs safely, efficiently and profitably. Even a large, specially configured scaffold can be transported in a small truck and set up by one man. You can buy or rent additional sections as needed for a specific application.

Hi-Lo Climbers have the application experience needed to develop the most usable and economical systems required by construction and maintenance industries. There is no simpler, performance-proven system.

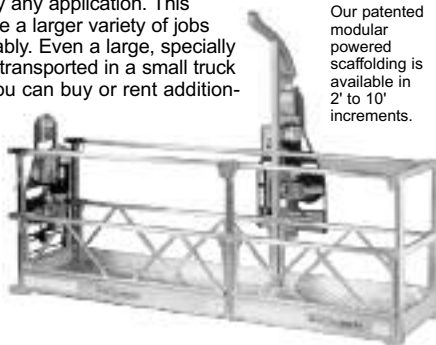

Our patented modular powered scaffolding is available in 2' to 10' increments.

Fold-Down Work Cage

Model WCFD

Rated 500 lbs. **Weight** 150 lbs.
Part 245-WCFD **Dim** 87" x 25" x 25"
Folded 87" x 24" x 12"

This unit will fit through a 12" x 24" opening when folded down. The front guard rail is adjustable. Four casters on the bottom make ground transfer easy. Roller bumper (included) protect the work surface during vertical movement.



Standard Modular Corner Sections

Angular sections are available in 15°, 30°, 40°, 60° and 90° corners.



90° Modular scaffolding section with guard rails



45° Modular scaffolding section with guard rails

Hi-Lo Climbers

Additional Safety Equipment and Accessories

Seldom is the versatility of Hi-Lo Climbers equipment more visible than when special rigging and platform configurations are called for. Engineering and sales work as a team to help customers find the right solution to every application.

ALUMINUM I-BEAM ASSEMBLY

Structural aluminum I-Beam (16"8" x 6") with splice plate. Can be dismantled into 8'4" sections for easy transport.

Part No. 265-300

TELESCOPIC OUTRIGGER

Constructed of 11 gauge square steel tubing. One 8' section of 2-1/2" square tubing fits into 3" square section. Telescopes from 8'3" to 15'.

Part No. 265-451

(Rolling outriggers with telescopic square tubing also available.)

ROLLING OUTRIGGER ASSEMBLY

Consists of 2 dolly frames with 10" pneumatic tires. Height of aluminum outrigger I-Beam can be adjusted to clear 48" parapet wall.

Part No. 265-400

COUNTERWEIGHTS

50 pound steel counterweights designed to fit on I-Beam assembly.

Part No. 265-200

GUARD RAIL SUPPORT

Attaches to either front or back of swing stage to support top and middle guard rails.

Part No. 260-005

CORNICE HOOKS

Ruggedly built steel cornice hooks are available in 9" to 36" sizes.

<u>Opening (in)</u>	<u>Part No.</u>
9	265-100-09
14	265-100-14
21	265-100-21
26	265-100-26
28	265-100-28
32	265-100-32
36	265-100-36

PARAPET CLAMPS

Adjustable clamps in steel or aluminum.

<u>Opening (in)</u>	<u>Part No.</u>
8 to 24	265-500-24
8 to 36	265-500-36

STIRRUP GUARD RAIL SUPPORT

Attaches to front and/or back of powered stirrup to provide additional safety and stability to guard rails.

Part No. 260-007

SPEED WINDER

Rugged, lightweight mechanism for coiling wire rope, electrical cable, hose and rope. Eliminates crossovers, entanglements and kinking. Size: 12" x 24" x 36" Capacity: 1000' 5/16" wire rope; 250', 10/3 electric cable.

Part No. 270-500

ROLLER BUMPERS

Non-marring rubber roller 12" wide x 3-1/16" dia. mounted in a variety of configurations to accommodate different applications.

Roller Bumper 12"

Part No. 260-020

Adjustable Roller Bumper 12"

Part No. 260-022

Modular Adjustable Roller Bumper

Part No. 260-018

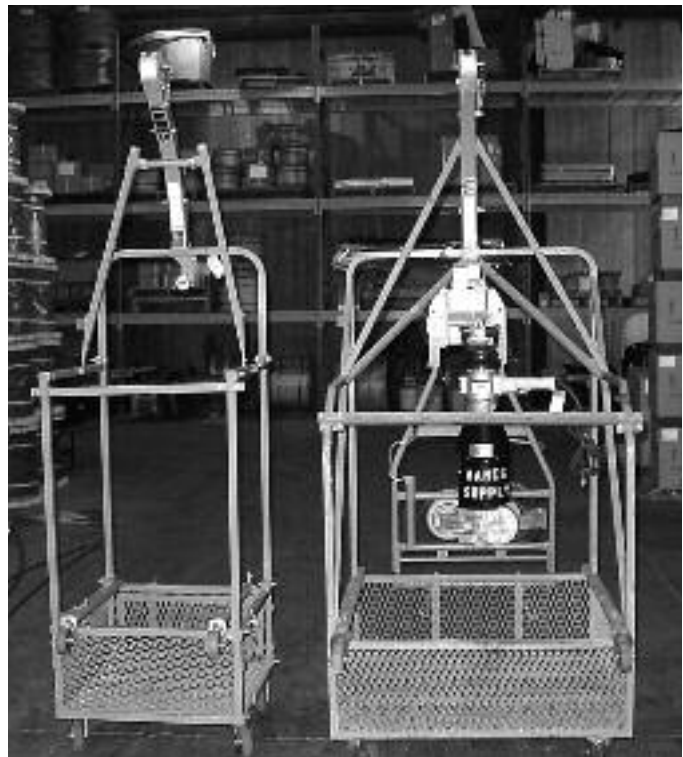

NOTES
