

SECTION 29
Electrical

ADAPTERS		Male Plug Replacement.....	29-3	POWER CONVERTERS	29-8
Electrical Cord.....	29-2-3	Multiple Outlet.....	29-2, 29-8	POWER CORDS	
BOOSTER CABLES	29-4	Power Block.....	29-2, 29-8	Adapter.....	29-2-3
BROODER	29-4	Power Indicator Light.....	29-1, 29-8	All Weather.....	29-1, 29-8
CABLE, ELECTRICAL		Power Strip.....	29-8	Bulk Power Cord.....	29-6
Booster.....	29-4	Replacement Ends.....	29-3	Circuit Analyzer.....	29-8
Bulk Powder Cord.....	29-6	Surge Protector.....	29-8	Colored.....	29-1
Cords.....	29-1-2, 29-8	Tri-Source Power Block.....	29-2, 29-8	Extreme Conditions.....	29-6-7
Lamp Cord.....	29-5	Twist Lock Adapters.....	29-2	Female Connector Replacement.....	29-3
Thermostat.....	29-5	Twist Lock Cord.....	29-2, 29-8	Four-Way Power Block.....	29-2
CONFINED SPACE		Vinyl Cords.....	29-1	GFCI.....	29-2-3, 29-8
Lights.....	29-7	W Adapter.....	29-2	Lamp.....	29-5
CONVERTERS		Y Adapter.....	29-2	Locking Cords.....	29-2, 29-8
Power.....	29-8	FLOOD		Male Plug Replacement.....	29-3
CORD, ELECTRICAL		Lights.....	29-4	Multiple Outlet.....	29-2, 29-8
3 to 2 Wire Adapter.....	29-3	FLUORESCENT		Power Block.....	29-2, 29-8
Adapters.....	29-2-3	Work Lights.....	29-4	Power Indicator Light.....	29-1, 29-8
All Weather.....	29-1, 29-8	GROUND FAULT CIRCUIT		Power Strip.....	29-8
Bulk Power Cord.....	29-6	INTERRUPTERS (GFCI).....	29-2-3, 29-8	Replacement Ends.....	29-3
Circuit Analyzer.....	29-8	HAZARDOUS LOCATION		Surge Protector.....	29-8
Colored.....	29-1	Light.....	29-6-7	Tri-Source Power Block.....	29-2, 29-8
Extreme Conditions.....	29-6-7	HEAT		Twist Lock Cord.....	29-2, 29-8
Female Connector Replacement.....	29-3	Lamp.....	29-4	POWER STRIP	29-8
Four-Way Power Block.....	29-2	INSPECTION		PROTECTOR	
GFCI.....	29-2-3, 29-8	Lights.....	29-6-7	Surge.....	29-8
Lamp.....	29-5	LAMP		QUARTZ	
Locking Cords.....	29-2, 29-8	Cords.....	29-5	Lights.....	29-5
Male Plug Replacement.....	29-3	LIGHTS		REEL	
Multiple Outlet.....	29-2, 29-8	Abrasive Blasting.....	29-6	Light.....	29-3-4
Power Block.....	29-2, 29-8	Area Lights.....	29-5, 29-6	SANDBLAST	
Power Indicator Light.....	29-1, 29-8	Battery Operated.....	29-4, 29-6-7	Deadman Devices.....	29-7
Power Strip.....	29-8	Brooder.....	29-4	Lights.....	29-6-7
Replacement Ends.....	29-3	Clamp-On.....	29-3	SURGE	
Surge Protector.....	29-8	Confined Entry.....	29-7	Protector.....	29-8
Tri-Source Power Block.....	29-2, 29-8	Explosion Proof.....	29-7	TRANSFORMER DECKS	29-8
Trouble Lights.....	29-3	Flood Light.....	29-4	TROUBLE	
Twist Lock Adapters.....	29-2	Fluorescent.....	29-4	Light.....	29-3
Twist Lock Cord.....	29-2, 29-8	GFCI.....	29-3	WORK	
Vinyl Cords.....	29-1	Hazardous Location.....	29-6-7	Lights.....	29-3-7
W Adapter.....	29-2	Heat Lamp.....	29-4	WORK SITE	
Y Adapter.....	29-2	Inspection.....	29-6-7	Lights.....	29-5-7
DEADMAN DEVICES	29-7	Light Systems.....	29-7		
ELECTRICAL		Outdoor.....	29-6-7		
Connectors.....	29-3	Painting.....	29-6		
Cord Adapters.....	29-2-3	Portable.....	29-3-7		
Plug.....	29-3	Quartz.....	29-5		
Wire, Bulk.....	29-6	Reel.....	29-3-4		
EXPLOSION PROOF		Reflector.....	29-4		
Lights.....	29-7	Stringer.....	29-5		
EXTENSION CORDS		Temporary.....	29-3-7		
3 to 2 Wire Adapter.....	29-3	Tripod Mounted.....	29-5		
Adapter.....	29-2-3	Trouble Light.....	29-3		
All Weather.....	29-1, 29-8	Vinyl Coated.....	29-3		
Bulk Power Cord.....	29-6	Wet Service.....	29-6-7		
Circuit Analyzer.....	29-8	Work Lights.....	29-3-7		
Colored.....	29-1	Work Site.....	29-5-7		
Extreme Conditions.....	29-6-7	Z-Frame.....	29-5		
Female Connector Replacement.....	29-3	POWER BLOCK			
Four-Way Power Block.....	29-2	Circuit Analyzer.....	29-8		
GFCI.....	29-2-3, 29-8	Four-Way.....	29-2		
Lamp.....	29-5	Ground Fault Circuit Interrupter (GFCI).....	29-8		
Locking Cords.....	29-2, 29-8	Power Indicator Light.....	29-1, 29-8		
		Three Way.....	29-2, 29-8		

Coleman Cable Systems, Inc.

Coleman Cable Systems, Inc.

POLAR/SOLAR® EXTENSION CORDS

Polar/Solar® Extension Cords

Coleman's T-Prene insulated all weather, all-condition cord

UL Listed-Meet OSHA requirements for Outdoor use.

Polar/Solar Cord is the all-purpose outdoor cord that always stays light and flexible, even under the most extreme conditions. Polar/Solar Cord will not crack, peel, flake or bake out even in the most bitter arctic cold.

Polar/Solar maintains total flexibility to -67° F. Rugged T-Prene insulation shrugs off oil, grease, acids, solvents and offers outstanding resistance to abrasion, ozone and other on-the-job hazards. Polar/Solar Cord weighs 1/3 less than ordinary cord.

CAT. NO.	WIRE GA/COND	WIRE TYPE	LENGTH (FT)	125V RATING
Three Conductor 300 Volt - Yellow				
01214	16/3	SJEOW	10	13A
01217	16/3	SJEOW	25	13A
01218	16/3	SJEOW	50	13A
01219	16/3	SJEOW	100	10A
01417	14/3	SJEOW	25	15A
01418	14/3	SJEOW	50	15A
01419	14/3	SJEOW	100	13A
01617	12/3	SJEOW	25	15A
01618	12/3	SJEOW	50	15A
01619	12/3	SJEOW	100	15A
01717	10/3	SJEOW	25	15A*
01718	10/3	SJEOW	50	15A*
01719	10/3	SJEOW	100	15A*

*Cap and Connector rated 15A.

Three Conductor 600 Volt - Yellow

CAT. NO.	WIRE GA/COND	WIRE TYPE	LENGTH (FT)	125V RATING
01467	14/3	SEOW	25	15A
01468	14/3	SEOW	50	15A
01469	14/3	SEOW	100	13A
01667	12/3	SEOW	25	15A
01668	12/3	SEOW	50	15A
01669	12/3	SEOW	100	15A

Polar/Solar Plus® Extension Cords Featuring a Power Indicator Light

UL Listed-Meet OSHA requirements for Outdoor use. Polar/Solar Plus Cord is the all-purpose portable outdoor cord that stays flexible even under the most extreme temperature conditions. The most rugged flexible easy-to-use cord. Saves you money because it lasts longer!

CAT. NO.	WIRE GA/COND	WIRE TYPE	LENGTH (FT)	125V RATING
01287	16/3	SJEOW	25	13A
01288	16/3	SJEOW	50	13A
01289	16/3	SJEOW	100	10A
01487	14/3	SJEOW	25	15A
01488	14/3	SJEOW	50	15A
01489	14/3	SJEOW	100	13A
01687	12/3	SJEOW	25	15A
01688	12/3	SJEOW	50	15A
01689	12/3	SJEOW	100	15A
01788	10/3	SJEOW	50	15A*
01789	10/3	SJEOW	100	15A*

*Cap and Connector rated 15A

American Contractor Series - Featuring a Power Indicator Light

American Contractor Cord is the all-purpose portable outdoor cord that stays flexible even under the most extreme temperature conditions. The rugged T*Prene™ construction is tough, easy-to-use and saves you money because it lasts longer!

CAT. NO.	WIRE GA/COND	WIRE TYPE	LENGTH (FT.)	125V RATING
01294	16/3	SJEOW	10	15A
01297	16/3	SJEOW	25	15A
01298	16/3	SJEOW	50	13A
01299	16/3	SJEOW	100	13A
01497	14/3	SJEOW	25	15A
01498	14/3	SJEOW	50	15A
01499	14/3	SJEOW	100	13A
01697	12/3	SJEOW	25	15A
01698	12/3	SJEOW	50	15A
01699	12/3	SJEOW	100	13A
01797	10/3	SJEOW	25	15A
01798	10/3	SJEOW	50	15A*
01799	10/3	SJEOW	100	15A*

*Cap and Connector rated 15A.



01417



01618



01487



01688

Vinyl Extension cords

UL Listed - Meet OSHA requirements for outdoor use. High visibility vinyl insulation resists oil, grease, moisture, abrasion and prolonged exposure to sunlight. Heavy-duty molded-on plugs and connectors.

CAT. NO.	WIRE GA/COND	WIRE TYPE	LENGTH (FT.)	125V RATING
Two Conductor Round Orange Cord - 300 Volt				
02204	16/2	SJTW	10	13A
02207	16/2	SJTW	25	13A
02208	16/2	SJTW	50	13A
02209	16/2	SJTW	100	10A



02207

CAT. NO.	WIRE GA/COND	WIRE TYPE	LENGTH (FT.)	125V RATING
Three Conductor Round Orange Cord - 300 Volt				
02304	16/3	SJTW	10	13A
02305	16/3	SJTW	15	13A
02307	16/3	SJTW	25	13A
02308	16/3	SJTW	50	13A
02309	16/3	SJTW	100	10A
02407	14/3	SJTW	25	15A
02408	14/3	SJTW	50	15A
02409	14/3	SJTW	100	13A
02507	12/3	SJTW	25	15A
02508	12/3	SJTW	50	15A
02509	12/3	SJTW	100	15A
02607	10/3	SJTW	25	15A*
02608	10/3	SJTW	50	15A*
02609	10/3	SJTW	100	15A*



02308

CAT. NO.	WIRE GA/COND	WIRE TYPE	LENGTH (FT.)	125V RATING
Three Conductor Round Orange Cord Large Cap and Connector - 600 Volt				
02457	14/3	STW	25	15A
02458	14/3	STW	50	15A
02459	14/3	STW	100	13A
02557	12/3	STW	25	15A
02558	12/3	STW	50	15A
02559	12/3	STW	100	15A



02507-00-30

CAT. NO.	WIRE GA/COND	WIRE TYPE	LENGTH (FT.)	125V RATING
Three Conductor Round Green Cords - 300 Volt				
02352	16/3	SJTW	20	13A
02356	16/3	SJTW	40	13A
02353	16/3	SJTW	80	13A

Color Cords - Three Conductor Round Cord - 300 Volt

Now Coleman offers Colored UL listed SJTW-A cords in stock! Coleman's colored cords now offer all the benefits of standard SJTW-A as well as: Owner identifiability, safety, loss (theft prevention).

CAT. NO.	WIRE GA/COND	WIRE TYPE	LENGTH (FT.)	125V RATING
02408-00-30	14/3	SJTW	50	15A
02408-00-31	14/3	SJTW	50	15A
02507-00-30	12/3	SJTW	25	15A
02507-00-31	12/3	SJTW	25	15A
02507-00-32	12/3	SJTW	25	15A
02507-00-33	12/3	SJTW	25	15A
02507-00-34	12/3	SJTW	25	15A
02508-00-30	12/3	SJTW	50	15A
02508-00-31	12/3	SJTW	50	15A
02508-00-32	12/3	SJTW	50	15A
02508-00-33	12/3	SJTW	50	15A
02508-00-34	12/3	SJTW	50	15A
02509-00-31	12/3	SJTW	100	15A
02509-00-31	12/3	SJTW	100	15A
02509-00-32	12/3	SJTW	100	15A
02509-00-33	12/3	SJTW	100	15A
02509-00-34	12/3	SJTW	100	15A

Color No.	Color Choice
30	Lime Cord/Purple Ends
31	Hot Pink Cord/Blue Ends
32	Green Cord/Orange Ends
33	Gray Cord/Red Ends
34	Blue Cord/White Ends

Electrical

Coleman Cable Systems, Inc.

Multiple Outlet Cords

Tri-Source™ - Three-Way Power Block

UL Listed - Meet OSHA Specifications. Includes protective covers for unused outlets.

CAT. NO.	WIRE GA/COND	WIRE TYPE	LENGTH (FT)	125V RATING
Yellow Polar/Solar®				
03412	12/3	SEOW	2	15A
03417	12/3	SJEOW	25	15A
03418	12/3	SJEOW	50	15A
03419	12/3	SJEOW	100	15A

Yellow Polar/Solar®-Featuring a Power Indicator Light

03482	12/3	SEOW	2	15A
03487	12/3	SJEOW	25	15A
03488	12/3	SJEOW	50	15A
03489	12/3	SJEOW	100	15A

American Contractor-300 Volt

03492	12/3	SJEOW	2	15A
03497	12/3	SJEOW	25	15A
03498	12/3	SJEOW	50	15A
03499	12/3	SJEOW	100	13A

Round Orange Vinyl

04217	14/3	SJTW	25	15A
04218	14/3	SJTW	50	15A
04219	14/3	SJTW	100	13A
04112	12/3	STW	2	15A
04117	12/3	SJTW	25	15A
04118	12/3	SJTW	50	15A
04119	12/3	SJTW	100	15A



03417

Quadnector™ Polar/Solar® - Four-Way Power Block

UL Listed - Meet OSHA Specifications. The versatility of 4-way power combined with the durability of Polar/Solar Cord. Receptacle and plug constructed with Coleman's all weather T-Prene so it maintains total flexibility to -67° F. Weighs 1/3 less than ordinary cordage, resists oil, grease, solvents, abrasion, ozone and other cordage hazards.

CAT. NO.	WIRE GA/COND	WIRE TYPE	LENGTH (FT)	125V RATING
300 Volt - Yellow				
04412	12/3	SJEOW	6	15A
04417	12/3	SJEOW	25	15A
04418	12/3	SJEOW	50	15A
04419	12/3	SJEOW	100	15A

600 Volt - Yellow

04512	12/3	SEOW	6	15A
04517	12/3	SEOW	25	15A
04518	12/3	SEOW	50	15A
04519	12/3	SEOW	100	15A

Quadnector™ Round Orange Vinyl - Four-Way Power Block

UL Listed - Meet OSHA Specifications

CAT. NO.	WIRE GA/COND	WIRE TYPE	LENGTH (FT)	125V RATING
300 Volt-Orange				
04102	12/3	SJTW	6	15A
04107	12/3	SJTW	25	15A
04108	12/3	SJTW	50	15A
04109	12/3	SJTW	100	15A

600 Volt-Orange

04202	12/3	STW	6	15A
04207	12/3	STW	25	15A
04208	12/3	STW	50	15A
04209	12/3	STW	100	15A



04412

American Contractor Quadnector™ - Four-Way Power Block

CAT. NO.	WIRE GA/COND	WIRE TYPE	LENGTH (FT)	125V RATING
04492	12/3	SJEOW	6	15A
04497	12/3	SJEOW	25	13A

- continues -

Multiple Outlet Cords (continued)

Trinector™ Orange Vinyl - Three-Way Power Block

Multiple duty extension cords with molded-on 3-way power outlets. Grounded for extra safety.

CAT. NO.	WIRE GA/COND	WIRE TYPE	LENGTH (FT)	125V RATING
04003	16/3	SJTW	3	13A
04006	16/3	SJTW	9	13A

Locking Extension Cords

UL Listed - Meet OSHA Specifications

Twist-to-lock extension cords and adapters designed for use in construction and industrial applications where extra protection and durability are needed. All are constructed with heavy-duty 12-gauge wire and molded locking male and female connectors.

CAT. NO.	WIRE GA/COND	WIRE TYPE	LENGTH (FT)	125V RATING
300 Volt - Yellow				
09208	12/3	SJTW	50	20A
09209	12/3	SJTW	100	15A

600 Volt - Yellow

09028	12/3	STW	50	20A
09029	12/3	STW	100	15A



09029

Adapters - Yellow

Converts a standard 15 Amp grounded receptacle to a twist-to-lock 20 Amp receptacle

09020	12/3	STW	9 inches	
-------	------	-----	----------	--

Converts a twist-to-lock 20 Amp receptacle to standard 15 Amp grounded receptacle

09021	12/3	STW	9 inches	
-------	------	-----	----------	--

09020

"Y" Adapter

09022	12/3	STW	20 inches	20A
-------	------	-----	-----------	-----

"W" Adapter

09023	12/3	STW	20 inches	20A
-------	------	-----	-----------	-----

GFCI-Ground Fault Circuit Interrupters/Safety

Provide personal protection from ground faults and open neutral conditions anywhere electrical equipment is used. Protection for the job site, plant floor or workshop. Each product is UL Listed and meet all OSHA specifications.

CAT. NO.	WIRE GA/COND	WIRE TYPE	LENGTH (FT)	125V RATING
Tri-Source® In-Line Heavy Duty GFCI 120 Volts/1800 Watts				
02841	12/3	SJEOW	2.5	15A

Tri-Source® In-Line Heavy Duty GFCI with Locking Ends 120 Volts/2400 Watts

02843	12/3	SJEOW	2.5	20A
-------	------	-------	-----	-----

Duplex Box GFCI 120 Volts/1800 Watts

02822	12/3	SJEOW	6	15A
-------	------	-------	---	-----

Quad Box - 15 Amp GFCI with Handle 120 Volts/1800 Watts

02816	12/3	SJEOW	6	15A
-------	------	-------	---	-----

Quad Box - 20 Amp with Locking Ends GFCI with Handle 120 Volts/2400 Watts

02821	12/3	SJEOW	6	20A
-------	------	-------	---	-----

User Attachable GFCI

Now you can connect your present cords, tools, etc., (up to 12 AWG) to make them comply with OSHA's GFCI requirements. Supplied with sealant to make unit rainproof.

02831	-	-	-	15A
-------	---	---	---	-----

GFCI Extension Cord with Molded Tri-Source®

02832	12/3	SJEOW	2	15A
02837	12/3	SJEOW	25	15A
02838	12/3	SJEOW	50	15A
02839	12/3	SJEOW	100	15A

- continues -



02841

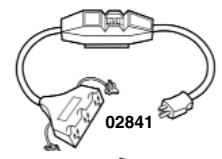

02822



02816



02821

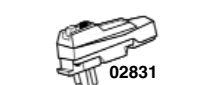

02831

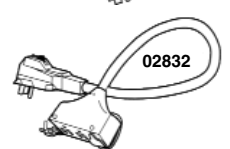

02832

Coleman Cable Systems, Inc.

GFCI-Ground Fault Circuit Interrupters/Safety (continued)

GFCI with Molded Tri-Source® with Power Indicator Light

03392	12/3	SJEW	2	15A
-------	------	------	---	-----

(with Power indicator light)

GFCI Extension Cord with Single Plug Outlet

02830	14/3	SJTW	2	15A
-------	------	------	---	-----

Ground Monitor

Plugs into outlets or extensions to test for OSHA required grounding and polarity

09909	-	-	-	15A
-------	---	---	---	-----

Adapters

UL Listed

CAT. NO. COLOR

3 to 2 Wire Adapter

09901	Grey
09901-97	Grey

3 Wire Cube Tap - Plastic

09913	Beige
09913-97	Beige

3 Wire Cube Tap - Rubber

09903	Yellow
09903-97	Yellow

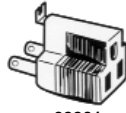

09901



09903/09913

Replacement Caps and Connectors

UL Listed

CAT. NO. DESCRIPTION

05980	Armored Male Cap, 3-Wire Dead Front, and Yellow Vinyl. Takes 12/3 and smaller wire.
05981	Armored Female Connector, 3-Wire Dead Front, and Yellow Vinyl. Takes 12/3 and smaller wire.
05984	All Vinyl, Large Dead Front, Male Cap, 3-Wire, Yellow Vinyl 15-Amp
05985	All Vinyl, Large Dead Front, Female Connector, 3-Wire, Yellow Vinyl 15-Amp
05990	Heavy Duty replacement male plug, Perma-Grip®
05991	Heavy Duty replacement female connector, Perma-Grip®
05992	Replacement Watertight male plug, Perma-Tite®
05993	Replacement Watertight female connector, Perma-Tite®
05994	Replacement Watertight Locking male plug, Perma-Tite®
05995	Replacement Watertight Locking female connector, Perma-Tite®

Trouble Lights

Trouble Lights Polar/Solar®

UL Listed-Meet OSHA Specifications for general use Heavy duty trouble lights featuring Coleman's exclusive T*Prene insulated Polar/Solar Cord. Stays flexible under all temperature extremes to -67° F. Exclusive one-piece injection molded handle.

Grounded, vinyl coated metal guard with switch and side outlet.

CAT. NO.	WIRE GA/COND	WIRE TYPE	LENGTH (FT)	CORD COLOR	125V RATING
05757	18/3	SJEO	25	Yellow	10A
05758	18/3	SJEO	50	Yellow	10A
05557	16/3	SJEO	25	Black	13A
05558	16/3	SJEO	50	Black	13A
05857	16/3	SJEO	25	Yellow	13A
05858	16/3	SJEO	50	Yellow	13A
05657	14/3	SJEO	25	Yellow	15A
05658	14/3	SJEO	50	Yellow	15A



05857

Aim Rite™ Trouble Light

UL Listed-Meet OSHA Specifications for general use. Trouble light with adjustable clamp/hook bracket puts the light where you need it. Exclusive one-piece injection molded handle with side outlet and switch for superior safety and durability. Available in vinyl or Polar/Solar cord.

CAT. NO.	WIRE GA/COND	WIRE TYPE	LENGTH (FT)	CORD COLOR	125V RATING
05437	16/3	SJT	25	Orange	13A
05447	16/3	SJEO	25	Yellow	13A



05447

Trouble Lights (continued)

Polar/Solar® COILITE™ -

Three Conductor Metal Cage - Black

Heavy-duty trouble light with rugged metal cage and injection-molded handle with grounded side outlet.

16 AWG, 3-conductor self-coiling Polar/Solar Cord with 3-prong right angle plug.

CAT. NO.	WIRE GA/COND	WIRE TYPE	LENGTH (FT)	CORD COLOR	125V RATING
05567	16/3	SJEO	4' - 20'	Black	13A

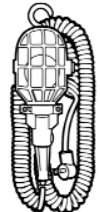

05567

GFCI Trouble Light

UL Listed - Meet OSHA Specifications for general use Heavy-duty trouble light with Coleman's Power Plug GFCI. Features Coleman's exclusive Polar/Solar Cord. Stays flexible under all temperature extremes to -67° F. One piece injection molded handle, grounded, vinyl-coated metal guard with switch and side outlet.

CAT. NO.	WIRE GA/COND	WIRE TYPE	LENGTH (FT)	CORD COLOR	125V RATING
03857	16/3	SJEO	25	Yellow	13A



03857

American Contractor

Trouble Light with one-piece injection molded handle, plastic coated metal guard, side outlet & switch.

CAT. NO.	WIRE GA/COND	WIRE TYPE	LENGTH (FT)	CORD COLOR	125V RATING
05897	16/3	SJEO	25	Yellow	10A
05898	16/3	SJEO	50	Yellow	10A

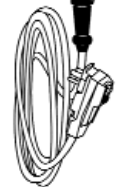

OSHA Approved Trouble Lights

Grounded plastic-coated metal guard. Meets OSHA requirements for use in commercial garages. No switch or outlet.

CAT. NO.	WIRE GA/COND	WIRE TYPE	LENGTH (FT)	CORD COLOR	125V RATING
05337	18/3	SJEO	25	Black	10A
05338	18/3	SJEO	50	Black	10A

UL Listed - Meet OSHA Specifications for general use

CAT. NO.	WIRE GA/COND	WIRE TYPE	LENGTH (FT)	CORD COLOR	125V RATING
05361	18/3	-	35	Black	-

Incandescent automatic retractable 35', no switch no cord outlet, plastic guard, 18/3 cord



05361

Orange Vinyl Cord

UL Listed - Meet OSHA Specifications for general use A complete line of rugged, "trouble-free" trouble lights for home or heavy-duty use. Heavy-duty handle fits naturally into the palm of your hand - for easy use. Outlet cover - protects against oil, grease and dirt.

CAT. NO.	WIRE GA/COND	WIRE TYPE	LENGTH (FT)	CORD COLOR	125V RATING
05006	18/2	SJT	15	Orange	10A
05007	18/2	SJT	25	Orange	10A
05008	18/2	SJT	50	Orange	10A

Two Conductor - Polypropylene guard with switch.

CAT. NO.	WIRE GA/COND	WIRE TYPE	LENGTH (FT)	CORD COLOR	125V RATING
05307	18/3	SJT	25	Orange	10A
05308	18/3	SJT	50	Orange	10A
05407*	16/3	SJT	25	Orange	13A
05408*	16/3	SJT	50	Orange	13A

*Not available with outlet cover.

Three Conductor - Grounded metal guard with side outlet with switch.

CAT. NO.	WIRE GA/COND	WIRE TYPE	LENGTH (FT)	CORD COLOR	125V RATING
05327	18/3	SJT	25	Orange	10A
05328	18/3	SJT	50	Orange	10A
05427	16/3	SJT	25	Orange	13A
05428	16/3	SJT	50	Orange	13A



05006



05327

Electrical

Coleman Cable Systems, Inc.

Worklights

12-volt Battery Lights

Trouble lights with heavy-duty clips, for use with cars, trucks, RV's, boats, tractors or any 12-volt battery. Convenient and easy to use.

CAT. NO.	VOLT RATING	WATT RATING	DESCRIPTION
Rough Service Replacement Bulbs			
05901	125	50	Rough Service
05902	125	75	Rough Service
05903	125	100	Rough Service

Heavy Duty Reflector Lights

UL Listed
Versatile multi-use utility lamps with polished and vented aluminum reflectors. Each unit features a double-ball universal joint, non-marring grips and a clamp-on bracket. On-off push through switch and rugged molded-on plug.

CAT. NO.	WIRE GA/COND	WIRE TYPE	LENGTH (FT)	CORD COLOR	125V RATING	REFL. DIA. (IN)
05922	18/2	SPT	6	Brown	10A	5.5
05932	18/2	SPT	6	Brown	10A	8.5
05939	18/2	SPT	6	Brown	10A	10.5
05936	Same as 05932, packaged in retail box					
05946	18/2	SJT	15	Black	10A	5.5
05956	18/2	SJT	15	Black	10A	8.5

Brooder and Heat Lamps

UL Listed
An ideal temporary heat source for pig and chicken brooders. Insulated two-piece porcelain sockets with heavy gauge aluminum reflectors, hang-up and optional clamp. Models with 8 foot lengths include T*Prene Rubber cord that retains flexibility in extreme cold.

CAT. NO.	WIRE GA/COND	WIRE TYPE	LENGTH (FT)	CORD COLOR	125V RATING	REFL. DIA. (IN)
05968	18/2	SJT	8	Black	10A	10.5
05961*	18/2	SJT	8	Black	10A	10.5

*Clamp included

Floodlight Holder

UL Listed - Indoor/outdoor floodlight holder, includes accessories for wall or ground mounting.

CAT. NO.	WIRE GA/COND	WIRE TYPE	LENGTH (FT)	CORD COLOR	125V RATING
05706	18/2	SJTW-A	6	Green	10A
05716*	18/2	SJTW-A	6	Green	10A

*Bulb included

Reel Lights with Circuit Breaker Handle

UL Listed - Meet OSHA Specifications
Rugged, heavy-duty trouble lights with convenient built-in retractable cord reel. Mounts easily for use in workshop, basement, or garage. Comes with hardware for wall or ceiling mounting. Circuit breaker prevents overload to cord reel as well as to household circuits.

CAT. NO.	WIRE GA/COND	WIRE TYPE	LENGTH (FT)	CORD COLOR	125V RATING
05360	18/3	SJT	20	Black	7A
05380	18/3	SJT	50	Black	7A
05570	16/3	SJT	30	Black	10A

OSHA Reel Lights

CAT. NO.	WIRE GA/COND	WIRE TYPE	LENGTH (FT)	CORD COLOR	125V RATING
05362	18/2	-	40	Black	-

UL Listed - Meet OSHA Specifications for general use
Compact fluorescent automatic retractable 40', no switch, 13 watts, 18/3 cord

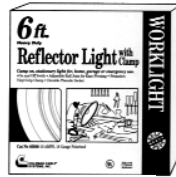

05936



05961



05968

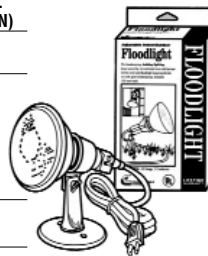

05716



05360



05362

Cord Reel Trinector™ Power Block

UL Listed - Meet OSHA Specifications for general use Unique Trinector three outlet power block with a heavy-duty retractable metal reel and locking mechanism. Ideal for home, workshop, garage or automotive. Includes hardware for mounting on wall or ceiling.

CAT. NO.	WIRE GA/COND	WIRE TYPE	LENGTH (FT)	CORD COLOR	125V RATING
04633	16/3	SJT	30	Black	10A

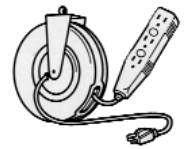

04633

Fluorescent Work Lights

UL Listed
Cool, glare-free fluorescent light that can be easily hung or held for maximum illumination and convenience. Clear protective sleeve guards fluorescent tube against breakage.

CAT. NO.	WIRE GA/COND	WIRE TYPE	LENGTH (FT)	CORD COLOR	125V RATING
Hand Held - 15 Watt					
05927	18/2	SJT	25	Yellow	7A
05928	18/2	SJT	50	Yellow	7A

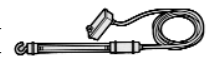

05927

Reel Mounted - 15 Watt

05907	18/2	SJT	25	Yellow	7A
05908	18/2	SJT	40	Yellow	7A

Hand Held - Compact 13 Watt

05930	18/2	SJT	15	Yellow	7A
05931	18/2	SJT	25	Yellow	7A

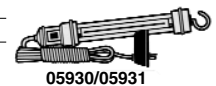

05930/05931

Reel Mounted - Compact 13 Watt

05934	18/2	SJT	40	Yellow	7A
05935	18/2	SJT	20	Yellow	7A

Professional Fluorescent Work Light with Outlet

UL Listed
Angled design directs the light toward work area. Collapsible swivel hook allows you to hang the light in unlimited direction. Includes grounded outlet plug on bottom of worklight handle. On/Off switch.

05998	16/3	SJT	2	Black	13A
05999*	16/3	SJT	15	Black	13A

*Detachable bracket with magnet and rubber cover attaches to car hoods and other metal surfaces without scuffing. Convenient bracket for easy wall attachment.

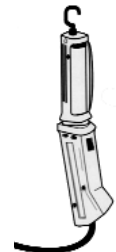

05998

Fluorescent Work Light Replacement Parts

05988	Replacement yellow plastic hanging hook (Used on all fluorescent products)				
05989	Replacement clear tube shield/reflector (Used on 15 watt only)				
05933	Replacement 13 watt u-shaped fluorescent bulb				

Automotive Booster Cables

500 Amp Polar-Glo™ Booster Cable Clamp Boxed 500 Amp Insulated No-Shock Polar-Glo™ Clamps

Featuring glow-in-the-dark polarity indicators. The Polar-Glo clamp is ergonomically designed to be handled easily by everyone. This clamp grips remarkably to both top and side post batteries firmly and easily. The extended jaw has grooves which conform to the side post, locking it in place. The Polar-Glo™ clamp is the perfect solution to the problem of jumping side post batteries. UL Listed.

Cat. No.	Cond Gauge	Length (ft)	Jacket Color
08465	8	12	Yellow
08466	8	16	Yellow
08565	6	12	Orange
08566	6	16	Orange
08665	4	12	Red
08666	4	16	Red
08660	4	20	Red
08662	4	25	Red



08465

Coleman Cable Systems, Inc.

Temporary Lighting

Temporary Outdoor Lighting Systems

Our durable indoor/outdoor lighting systems are available in a variety of lengths, gauge and styles. All feature lamp sockets in 10 foot increments.

CAT. NO.	WIRE GA/COND	LENGTH (FT)	TYPE OF GUARD	125V RATING
----------	--------------	-------------	---------------	-------------

Cord-O-Lite™

UL Listed/Complies with 1996 National Electric Code/Meet OSHA Specifications
Our most rugged lighting system. Heavy duty 12/3 SJTW-A (yellow) with molded light sockets. Accommodates bulbs up to 150 watts. Available with easy-open plated metal lamp guards or snap-on plastic guards. Standard 15 amp molded or 20 amp locking ends.

Standard 15 amp molded connectors

07538	12/3 SJTW	50	Metal	15A
07539	12/3 SJTW	100	Metal	15A
07548	12/3 SJTW	50	Plastic	15A
07549	12/3 SJTW	100	Plastic	15A

Locking 20 amp connectors

07558	12/3 SJTW	50	Metal	20A
07559	12/3 SJTW	100	Metal	20A
07568	12/3 SJTW	50	Plastic	20A
07569	12/3 SJTW	100	Plastic	20A



07308/07309



07128/07129

Lite Streamer

UL Listed/Complies with 1996 National Electric Code/Meet OSHA Specifications
This economical system features a 14/2 FY cable assembly (yellow) and our easy-open, snap-on plastic guards. Accommodates bulbs up to 150 watts. Does not include caps or connectors.

07128	14/2 FY	50	Plastic	15A
07129	14/2 FY	100	Plastic	15A

Economy Lite Streamer

Our most economical system! Features 14 gauge MTW (open conductors) and our easy open, snap-on plastic guards. Accommodates bulbs up to 150 watts. Does not include caps or connectors.

07308	14 ga. MTW	50	Plastic	15A
07309	14 ga. MTW	100	Plastic	15A

Replacement Guards

CAT. NO.	DESCRIPTION
07200	Replacement Metal Guard
07300	Replacement Plastic Guard

Luma-Site™

UL Listed
When the job must go on, rely on Coleman's Luma-Site to light the way. For the times when the weather does not cooperate or the job goes on into the night, be prepared... make our Luma-Site part of your everyday tool list. When you need them, you will be glad to know that all Coleman Cable's Portable Luma Site lights feature sturdy tri-pod footing*, pivoting heads that allow you to direct the 500 watts of "Instant On" light in any direction, and a telescoping post* that extends up to 7 feet. When the job is done, you will be glad that they feature a convenient on/off power switch, are easily transported from site-to-site, and are completely collapsible for easy storage. Coleman Cable's Luma-Site... Sturdy, Reliable and Powerful... Make it part of your Tools of The Trade.
*Except for 07775

Features

- UL Listed
- 500 Watts of "Instant-On" light
- Wire guards protect lens and bulb
- 1/3 brighter than standard incandescent lighting
- 8-foot grounded cord with molded male plug
- Heavy-duty powder coated casting
- Telescoping post - reaches height of 7 feet
- Pivoting head - allows you to direct the light beam
- Tri-pod base for sturdy footing - collapses for storage
- Collapsible - easy to transport from site-to-site

- continues -

Temporary Lighting (continued)

Portable Lighting Systems

UL Listed

CAT. NO. DESCRIPTION

Hand-Held Light System

07775 500 Watt Bulb. Adjustable pivot handle with weatherproof On/Off Power Switch. No tri-pod and telescoping post

Dual Head Light System

07776 Two 500 Watt Pivoting Heads, Separate On/Off Power Switches for Each Fixture. Tri-Pod Included.

Single Head Light System

07777 500 Watt Bulb. Ideal for Connecting Lights in Series. Tri-Pod Included.

Single Light System with magnetic Mounting Feature

07885 500 Watt Light Mounts on Tri-Pod (not included) or Any Metal Structure.

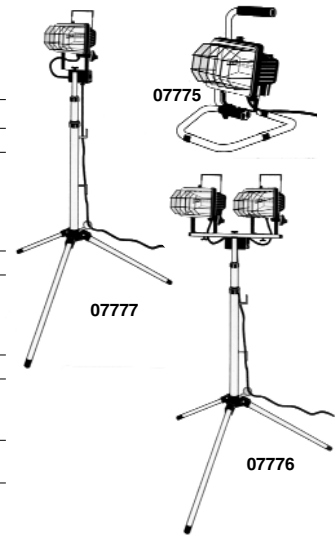

Lamp Cord - Thermostat Cable

Lamp Cord

UL Listed

300 volt rip type cord with SPT-1 PVC insulation. 2 conductors of parallel stranded copper; one conductor ribbed for polarity. Specify color when ordering.

CAT. NO.	WIRE GA/COND	WIRE TYPE	LENGTH (FT)	CORD COLOR	125V RATING
60000-66-07	18/2	SPT-1	250	Brown	10A
60000-66-01	18/2	SPT-1	250	White	10A
60000-66-18*	18/2	SPT-1	250	Clear	10A
60000-66-08	18/2	SPT-1	250	Black	10A
60000-66-19*	18/2	SPT-1	250	Gold	10A
60000-66-21*	18/2	SPT-1	250	Silver	10A
60126-66-07	16/2	SPT-2	250	Brown	10A
60126-66-01	16/2	SPT-2	250	White	13A
60126-66-08	16/2	SPT-2	250	Black	13A

*Non UL



Thermostat Cable

UL Listed

For use with thermostat controls and other low-voltage systems - PVC jacket overall. 20 gauge.

CAT. NO.	WIRE GA/COND	CORD COLOR	LENGTH (FT)
70002-05-07	20/2	Brown	500
70003-05-07	20/3	Brown	500
70004-04-07	20/4	Brown	250
70005-04-07	20/5	Brown	250
70006-04-07	20/6	Brown	250
70007-04-07	20/7	Brown	250
70008-04-07	20/8	Brown	250
70010-04-07	20/10	Brown	250
70012-04-07	20/12	Brown	250
70082-66-07	18/2	Brown	500
70083-66-07	18/3	Brown	500
70084-66-07	18/4	Brown	250
70085-66-07	18/5	Brown	250
70086-66-07	18/6	Brown	250
70087-66-07	18/7	Brown	250
70088-66-07	18/8	Brown	250
70090-66-07	18/10	Brown	250
70092-66-07	18/12	Brown	250

- continues -

Electrical

Coleman Cable Systems, Inc./Western Technology

Portable Service Cord

CAT. NO.	WIRE GA/COND	WIRE TYPE	LENGTH (FT)	CORD COLOR
----------	--------------	-----------	-------------	------------

Orange Vinyl - Two Conductor - 300 volt

20205-66-03	18/2	SJTW	250	Orange
20206-66-03	16/2	SJTW	250	Orange

Orange Vinyl - Three Conductor - 300 volt

20305-66-03	18/3	SJTW	250	Orange
20306-66-03	16/3	SJTW	250	Orange
20307-66-03	14/3	SJTW	250	Orange
20308-66-03	12/3	SJTW	250	Orange
20309-04-03	10/3	SJTW	250	Orange

Orange Vinyl - Three Conductor - 600 volt

21307-04-03	14/3	STW	250	Orange
21308-04-03	12/3	STW	250	Orange

Seoprene 105 - 600 volt - Oil Resistant

UL Listed - Coleman's exclusive all-weather, all-condition cordage. Made with Seoprene, so it's always lightweight and easy to handle - maintains total flexibility to -40° C. Can't crack, flake or bake out in punishing heat... won't swell or stiffen in arctic cold. Offers excellent resistance to abrasion, oil, acids and ozone.

22225-04-08	18/2	SEOW-A	250	Black
22325-04-08	18/3	SEOW-A	250	Black
22226-04-08	16/2	SEOW-A	250	Black
22326-04-08	16/3	SEOW-A	250	Black
22227-04-08	14/2	SEOW-A	250	Black
22327-04-08	14/3	SEOW-A	250	Black
22427-04-08	14/4	SEOW-A	250	Black
22228-04-08	12/2	SEOW-A	250	Black
22328-04-08	12/3	SEOW-A	250	Black
22428-04-08	12/4	SEOW-A	250	Black
22229-04-08	10/2	SEOW-A	250	Black
22329-04-08	10/3	SEOW-A	250	Black
22429-04-08	10/4	SEOW-A	250	Black
22320-04-08	8/3	SEOW-A	250	Black
22420-04-08*	8/4	SEOW-A	250	Black
22321-04-08	6/3	SEOW-A	250	Black
22421-04-08*	6/4	SEOW-A	250	Black

* Non UL



Bulk Wire

CAT. NO.	SIZE (AWG)	JACKET COLOR	NOM. STRAND	NOM. OD	LGTH. (FT)	WELDING AMPERES 50ft. - 100ft.	150 ft.	WT. MFT
----------	------------	--------------	-------------	---------	------------	--------------------------------	---------	---------

Colflex™ Welding Cable - Specifications - 105° Celsius 600V

10011-04-08	6	Black	7/37/30	.350	250	-	-	120
10012-04-08	4	Black	7/60/30	.400	250	100	-	177
10013-04-08	2	Black	19/35/30	.475	250	150	100	264
10014-04-08	1	Black	19/44/30	.505	250	200	200	329
10015-04-08	1/0	Black	19/55/30	.575	250	250	250	421
10016-04-08	2/0	Black	19/70/30	.635	250	300	350	535
10017-04-08	3/0	Black	19/88/30	.720	250	400	400	675
10018-04-08	4/0	Black	19/111/30	.780	250	500	500	836

Western Technology

Series 4000

Temporary Work Site Lights

4100 "SITE LIGHT"

Three Directional Area Light with magnetic mounts, 120V, uses standard par 38, 150 watt maximum lamp. Constructed of durable Polytech. Optional Steel Protective Lamp guard #4105-3 offers additional protection against bulb breakage. Light comes standard with 25' cord. Longer lengths upon request.



4210 "SITE LIGHT"

Single Outlet Par Lamp Holder with large handle and removable magnetic swivel mount, 12V or 120V, uses standard par 38, 150 watt maximum lamp with retainer ring #4105-1, or any par 38, 250 watt lamp with retainer ring #4105-2. Light comes standard with 25' cord. Longer lengths upon request.



Series 3000, 5000 & 8000

SANDBLASTING, PAINTING & INSPECTION LIGHTS

3200

Abrasive Blast Light/Deadman

Remote Control - offered in electric and pneumatic types. Remote control operates independently of light. Light may be removed when not needed. System is ideal for blast cleaning large easy to reach areas.



3300

Abrasive Blast/Multipurpose Light

(120V in/17V out) integrates compressed air to cool bulb for maximum light. Complete with six (6) feet of cord. Available as a system including power pack and cord connectors. Multiple outlet power packs are available. System provides dust penetrating light with maximum operator flexibility. Optional Light Stanchion #3112. Also available in 220V.



3300S100LT

Liquid Tight Light System integrates compressed air to cool bulb for maximum light. It is designed for applications such as hydro-blasting where moisture is present. Single outlet 120V in/17V out system. Not for submersion.



3400

No air Multipurpose/Abrasive Blast Light

(12V) complete with six (6) feet of cord. System includes power pack. Also in 220V. Model 3400B may be connected directly to 12VDC battery and comes with battery clamps. Multi-outlet systems available. Optional Light Stanchion #3112.



SEE ALSO: 5000 "Spray Light" and 8000 "The Inspector" Under Hazardous Location Lights

Western Technology

Series 5000, 7000, 8000 & 9000 Hazardous Location Lights

5000 "SPRAYLIGHT" Explosion Proof Hand Held/Hose Mounted Light System.

120V in/17V out designed for use in "confined entry" locations. Electric and compressed air service are combined in a single abrasive resistant supply line. Also available in 220V. HAZARDOUS LOCATION LIGHT • CLASS I, II • DIV. I, II GROUP D, G STANDARDS.



7000

Explosion Proof Drop Light with tempered glass globe. Full swivel hook and heavy duty guard assembly of non-sparking aluminum. Rain tight and weather resistant. Comes with abrasion resistant 14/3 mining cable with factory wired GFI with reset. HAZARDOUS LOCATION LIGHT • CLASS I, II • DIV. I, II GROUP D, G STANDARDS.



8000 "THE INSPECTOR" Battery Operated Hazardous

Location Light. Uses 6 volt leak proof Gel Cell Batteries, electronic on/off switch. Battery tester with LED discharge indicator & electronic switch. Includes battery charger. Integrated "hands-free" feature. HAZARDOUS LOCATION LIGHT • CLASS I, II • DIV. I, II GROUP D, G STANDARDS.



9000 "LIGHT BOX"

Modular Lighting System. The LIGHT BOX was originally designed to withstand the severe and hazardous working environments common to shipyard sandblasting and painting. However, with the 360° light pattern, nonconductive and shatterproof polyurethane construction, it is appropriate for maintenance activities in industries as diverse as food/beverage, hydroelectric power plants, and rail car repair. Available as components that can be assembled into individual lights or multi-light modular lighting system. Major components are: LIGHT TOWER with and without patented circuit interrupter sensor, LIGHT GLOBE and POWER LINE.

Available in three models:

- 9000S "Light Box" – Standard Service Model
- 9000SP "Light Box" – Wet Service Model
- 9000EXP "Light Box" – Hazardous Service Model



Series 1000 Deadman Devices, Pneumatic & Electric (2 & 3-wire)

**1001 "THE REDHEAD"
Rebuildable Electric Deadman Remote
Control Switch.** For any electric remote control system. 1001-REP - 2 Wire and 1001-REP-3 - 3 wire. Complete rebuild kit available.



**1001-4 "ZEUS 2"
Factory Sealed Electric Deadman Remote
Control Switch.** Counted on by contractors worldwide for maximum safety and reliability in extremely harsh conditions. For any electric remote control system. Mounts directly onto blast hose.



**1002 & 1002-1
Pneumatic Deadman Twin Line Remote
Control Valve.** Mounts Directly to hose with hose clamps. Features self-cleaning air bleed-off mechanism. Part #1002 for 1/4" air hose. Part #1002-1 for 3/16" air hose.



**1003
Pistol Grip Type Electric
Deadman Switch.**



**1004
Wrist-EZ. Electric Deadman Control**
with trigger activated pistol grip designed to reduce carpal tunnel syndrome. Blast hose mounts to tip of control. Trigger guard protects hand from ricocheting abrasive and accidental activation. Unit is ideal for blasting flat surfaces.



**1004-CM "CONTROL MASTER"
Factory Sealed Electric Deadman
Control Switch** with dual electric circuits for maximum safety. Primary On/Off switch controls electrical current to "deadman" toggle. Complete with four (4) feet of cord.



Electrical

Woods®

Woods®

Yellow Jacket® Power Cords - Contractor Grade

Full Lifetime Guarantee - Super Flexible Power Cords with Power Indicator Light

Yellow Jacket® Power Cords

Our exclusive Yellow Jacket® compound is more flexible and abrasion resistant at any temperature than standard vinyl compounds or blue cold weather cords. (Don't confuse Woods' unique high-gloss super flexible wire with yellow cords made of regular SJTW-A or SJEOW-A compounds.) Yellow Jacket® cords are the best on the job site. Yellow Jacket® is three times as abrasion resistant as standard vinyl. PowerLite power indicator plug glows when the cord has power. Extra heavy, clear molded plugs are rugged and durable.

CAT NO.	GAUGE/COND	WIRE TYPE	CORD LGTH (FT)	CORD COLOR	125V RATING
2886	14/3	SJTW-A	25	Yellow	15A
2887	14/3	SJTW-A	50	Yellow	15A
2888	14/3	SJTW-A	100	Yellow	13A
2883	12/3	SJTW-A	25	Yellow	15A

Individually packaged in easy-to-carry corrugated display box.

2884	12/3	SJTW-A	50	Yellow	15A
2885	12/3	SJTW-A	100	Yellow	15A
2805	10/3	SJTW-A	50	Yellow	15A
2806	10/3	SJTW-A	100	Yellow	15A

Yellow Jacket® Power Cords with T-Blade Plug

The only molded T-Blades on the market today! T-Blade female plug accepts tools with 15 amp and 20 amp plugs. T-Blade on female plug only. Individually packaged in easy-to-carry corrugated display box.

CAT NO.	GAUGE/COND	WIRE TYPE	CORD LGTH (FT)	CORD COLOR	125V RATING
2991	10/3	SJTW-A	50	Yellow	20A
2992	10/3	SJTW-A	100	Yellow	20A

Yellow Jacket® Power Blocks

Yellow Jacket® Power Block three-outlet adapters with exclusive high-gloss, extra durable, super flexible wire. Solid molded power block head stands up to heat, cold and rough use on job sites.

CAT NO.	GAUGE/COND	WIRE TYPE	CORD LGTH (FT)	CORD COLOR	125V RATING
2827	12/3	SJTW-A	50	Yellow	15A
2820	12/3	SJTW-A	100	Yellow	15A

Extra heavy duty 600 Volt insulated wire.

2882	12/3	STW-A	2	Yellow	15A
------	------	-------	---	--------	-----

With circuit breaker in the male plug. Extra heavy duty 600 Volt insulated wire.

2881	12/3	STW-A	2	Yellow	15A
------	------	-------	---	--------	-----

Yellow Jacket® with Ground Fault Circuit Interrupters

Yellow Jacket® GFCI cords have a right angle male plug ground fault circuit interrupter. Provides maximum safety. Manual test/reset buttons. PowerLite female plug glows when the cord has power.

CAT NO.	GAUGE/COND	WIRE TYPE	CORD LGTH (FT)	CORD COLOR	125V RATING
2879	14/3	SJTW-A	6	Yellow	15A
2877	12/3	SJTW-A	2	Yellow	15A

With 3-outlet power block.

2814	12/3	SJTW-A	2	Yellow	15A
------	------	--------	---	--------	-----

With 3-outlet black molded power block. Without PowerLite.

2848	12/3	SJTW-A	2	Yellow	15A
------	------	--------	---	--------	-----



2887



2885



2991



2882



2879

Yellow Jacket® Contractor Grade (continued)

Yellow Jacket® with Circuit Analyzer Power Block

Yellow Jacket® exclusive Circuit Analyzer cords check the outlet's circuit for ground and polarity as required in OSHA Standard 1910.304. Circuit Analyzer is protected in solid molded head. 600 Volt jacket.

CAT NO.	GAUGE/COND	WIRE TYPE	CORD LGTH (FT)	CORD COLOR	125V RATING
2815	12/3	STW-A	2	Yellow	15A

With circuit breaker in male plug.

2816	12/3	STW-A	2	Yellow	15A
------	------	-------	---	--------	-----

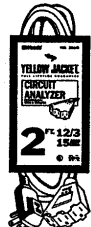

2815

Yellow Jacket® Twist-To-Lock

Woods' Yellow Jacket® Twist-To-Lock is the best solution to your contractor customer's needs. PowerLite plug contains a tough neon bulb that glows when there is power to the female plug. The bulb is rated for 15 years of daily use. Extra heavy, clear molded plugs. Individually packaged in easy-to-carry corrugated box. Available in 300 Volt (SJTW-A) and 600 Volt (STW-A) jackets.

CAT NO.	GAUGE/COND	WIRE TYPE	CORD LGTH (FT)	CORD COLOR	125V RATING
---------	------------	-----------	----------------	------------	-------------

Heavy Duty 300V Insulated Wire

2515	12/3	SJTW-A	50	Yellow	15A
2516	12/3	SJTW-A	100	Yellow	15A
2822	10/3	SJTW-A	50	Yellow	20A
2823	10/3	SJTW-A	100	Yellow	20A

Extra heavy duty 600V insulated wire - Still most flexible at all temperatures.

1487	12/3	STW-A	50	Yellow	15A
1514	12/3	STW-A	100	Yellow	15A

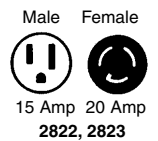
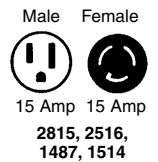

Contractor - Multiple Outlets

Woods' Contractor program offers a complete line of power converters and surge protection products. Woods' selection of converters ranges from a simple plug adapter to six-outlet converters and strips. All Woods' multi-outlet products are carded, blister packed, boxed or in a clamshell for attractive display at point of sale.

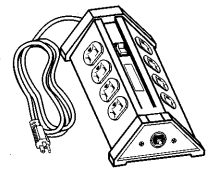

2178

Converters

CAT #	COND	TYPE	DESCRIPTION	WIRE	COLOR
-------	------	------	-------------	------	-------

Strips - Multiple outlet strips convert a standard wall outlet into six or eight grounded outlets. Built-in circuit breaker.

2174	3	6-Outlet	Plastic, 8' cord	14/3 SJT	Ivory
2177	3	4-Outlet	Metal, 4' cord	14/3 SJT	Black
2178	3	8-Outlet	Metal, 6' cord	14/3 SJT	Black
7405	3	4-Outlet	Shop Block™ Plastic strip with hinged outlet covers, 10' cord	14/3 SJT	Black/Yellow
7408	3	6-Outlet	Transformer Deck™ Plastic strip fits 2 transformers and 4 regular outlets, 4' cord	14/3 SJT	Black/Yellow
7411	3	6-Outlet	Tough Strip™ Metal strip, 4' cord	14/3 SJT	Black/Yellow

Contractor - Surge Protection

All units meet or exceed UL 1449 requirements for Transient Voltage Surge Suppressors (TVSS). Protect expensive electronic equipment from power surges of up to 6,000 volts. MAXIMUM protection units have a clamping voltage rating of 330 volts for ALL THREE LINES (the lowest rating under UL 1449). FULL protection units have an 1875 watts. Some protect against surges on phone or coaxial lines. All strips have a 4/14/3 SJT cord.

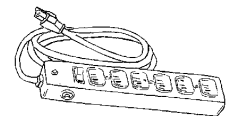

0417

Job Site Surge Protection

Cat No.	Cond	Protection Level	Type	Description	UL Clamping Voltage @ 500 amps	Color	Std. Pack
0417	3	Full	6-Outlet	Metal Surge Strip	400V	Ivory	12
0418	3	Full	6-Outlet	Surge Strip	400V	Ivory	12